

User's Manual



DIN EN ISO 9001
Certificate: 01 100 98505



LIMIT CONTROL L91 Microprocessor Based Limit Controller



RoHS



BrainChild

UM0L911F

Warning Symbol

The Symbol calls attention to an operating procedure, practice, or the like, which, if not correctly performed or adhered to, could result in personal injury or damage to or destruction of part or all of the product and system. Do not proceed beyond a warning symbol until the indicated conditions are fully understood and met.

Use the Manual

- Installers Read Chapter 1, 2
- System Designer Read All Chapters
- Expert User Read Page 12

NOTE:

It is strongly recommended that a process should incorporate a LIMIT CONTROL like L91 which will shut down the equipment at a preset process condition in order to preclude possible damage to products or system.

Information in this user's manual is subject to change without

This manual is applicable for the products with software version 19 and later version.

Copyright © 2023, The Brainchild Electronic Co., Ltd., all rights reserved. No part of this publication may be reproduced, transmitted, transcribed or stored in a retrieval system, or translated into any language in any form by any means without the written permission of the Brainchild Electronic Co., Ltd.

Contents

	Page No		Page No
Chapter 1 Overview		3-4 PV Shift -----	35
1-1 General -----	5	3-5 Digital Filter -----	35
1-2 Ordering Code -----	6	3-6 Process Alarms -----	36
1-3 Programming Port -----	7	3-7 RS-485 Communication --	37
1-4 Keys and Display -----	7	3-8 Display Mode -----	38
1-5 Menu Overview -----	12	3-9 Signal Conditioner DC Power Supply -----	38
1-6 Limit Control Operation --	13	3-10 Remote Reset -----	40
1-7 Parameter Descriptions -	16	3-11 Remote Lock -----	40
		3-12 Limit Annunciator -----	41
		3-13 Reference Data -----	41
Chapter 2 Installation		Chapter 4 Applications	----- 42
2-1 Unpacking -----	22	Chapter 5 Calibration	----- 43
2-2 Mounting -----	22	Chapter 6 Specifications	----- 48
2-3 Wiring Precautions -----	23	Chapter 7	
2-4 Power Wiring -----	25	Modbus Communications	----- 52
2-5 Sensor Installation Guidelines -----	25	Appendix	
2-6 Thermocouple Input Wiring -----	26	A-1 Error codes	----- 61
2-7 RTD Input Wiring -----	27		
2-8 Linear DC Input Wiring --	28		
2-9 Event Input Wiring -----	29		
2-10 Output 1 Wiring -----	30		
2-11 Output 2 Wiring -----	31		
2-12 RS-485 -----	32		
Chapter 3 Programming			
3-1 Process Input -----	33		
3-2 Limit Control -----	34		
3-3 Set point Range -----	34		

Figures & Tables

	Page No
Figure 1-1 Programming Port Location -----	7
Figure 1-2 Front Panel Display -----	8
Figure 1-3 Power Up Sequence -----	10
Figure 1-4 High Limit Operation -----	13
Figure 1-5 Low Limit Operation -----	14
Figure 1-6 High/Low Limit Operation -----	15
Figure 2-1 Mounting Diagram -----	23
Figure 2-2 Lead Termination -----	24
Figure 2-3 Rear Terminal Connection Diagram -----	24
Figure 2-4 Power Supply Connections -----	25
Figure 2-5 Thermocouple Input Wiring -----	27
Figure 2-6 RTD Input Wiring -----	27
Figure 2-7 Linear Voltage Input Wiring -----	28
Figure 2-8 Linear Current Input Wiring -----	28
Figure 2-9 Event Input Wiring -----	29
Figure 2-10 Output 1 Wiring -----	30
Figure 2-11 Output 2 Wiring -----	31
Figure 2-12 RS-485 Wiring -----	32
Figure 3-1 Conversion Curve for Linear Type Process Value-----	33
Figure 3-2 Filter Characteristics -----	35
Figure 3-3 Normal Process Alarm -----	37
Figure 3-4 Latching Process Alarm -----	37
Figure 3-5 DC Power Supply Application -----	39
Figure 3-6 Remote Reset Application -----	40
Figure 3-7 Remote Lock Application -----	40
Figure 4-1 Over Temperature Protection with Remote Reset	42
Figure 5-1 Flow chart for Manual Calibration -----	44
Figure 5-2 Cold Junction Calibration Setup -----	45
Figure 5-3 RTD Calibration -----	46
Table 1-1 Display Form of Characters -----	9
Table 6-1 Input Characteristics -----	49

Chapter 1 Overview

1-1 General

The limit control **L91** is an over temperature protection or a high limit safety device with a latching output, that removes power in an abnormal condition during the process is higher than the high limit set point or lower than the low limit set point.

The unit is powered by 11-26 or 90-264 VDC/VAC supply, incorporating a 3 amp. form C relay for limit control, an universal input which is fully programmable for PT100, thermocouple types J, K, T, E, B, R, S, N, L and 0~60mV, an option port available for one of the following functions: alarm output, RS-485 communication interface, DC power supply output, limit annunciator output and event input. Alternative output options include SSR drive and triac . The input signal is digitized by using a **18-bit A to D** converter. Its **fast sampling rate** (5 times/second) allows the L91 to control fast process such as pressure and flow.

Digital communication RS-485 is available as an additional option. This option allows L91 to be integrated with supervisory control system. An alarm output is another option. A variety of alarm function and alarm mode can be programmed for a specific application. The DC power supply output option is used for an external sensor or transmitter. The event input option can be programmed for remote reset or remote lock signal input. The limit annunciator option can be used to control an alarm buzzer.

Three kinds of method can be used to program L91. **1.** use keys on front panel to program the unit manually, **2.** Use a PC and setup software to program the unit via RS-485 port and **3.** Use a pc and configuration software to program the unit via **programming port**.

High accuracy, maximum flexibility, fast response and **user friendly** are the main features of L91.

1-2 Ordering Code

L91—
1 2 3 4 5 6

Power Input —
4: 90 - 264 VAC, 47-63 HZ
5: 11 - 26 VAC or VDC

Signal Input —
1: Standard Input
Thermocouple: J, K, T, E, B,
R, S, N, L, C, P
RTD: PT100 DIN, PT100 JIS
mV: 0~60 mV
2: Voltage: 0-1 V
3: Voltage : 0-10 V
4: Current: 0-20mA/ 4-20mA
5: Voltage: 0-5 V/ 1-5 V

Output 1 —
0: None
1: Form C relay rated 2A/240VAC
2: Pulsed voltage to drive SSR,
5V/30mA
6: Triac Output 1A / 240VAC,SSR
C: Pulsed voltage to drive SSR,
14V/40mA

Option —
0: None
1: Form A Relay 2A/240VAC
2: Pulsed voltage to drive SSR, 5V / 30mA
6: Triac Output, 1A / 240VAC, SSR
7: Isolated 20V / 25mA DC Output
Power Supply
8: Isolated 12V / 40mA DC Output
Power Supply
9: Isolated 5V / 80mA DC Output
Power Supply
A: RS-485
B: Event input
C: Pulsed voltage to drive SSR, 14V/40mA
D: Retransmit 4-20mA / 0-20mA
E: Retransmit 1-5V / 0-5V
F: Retransmit 0-10V

Standard leave blank
Special Order AA-ZZ

Example

Standard Model:

L91-4110

- 90 - 264 operating voltage
- Input: Standard Input
- Output 1: Relay
- Option: None

Accessories

OM94-6 = Isolated 1A / 240VAC Triac Output Module (SSR)

OM94-7 = 14V/40mA SSR Drive Module

DC94-1 = Isolated 20V / 25mA DC Output Power Supply

DC94-2 = Isolated 12V / 40mA DC Output Power Supply

DC94-3 = Isolated 5V / 80mA DC Output Power Supply

CM96-1 = Isolated RS-485 Interface Module

CM96-3 = Isolated 4-20mA / 0-20mA Retransmission Module

CM96-4 = Isolated 1-5V / 0-5V Retransmission Module

CM96-5 = Isolated 0-10V Retransmission Module

EI96-1 = Event Input Module

CC91-2 = Programming port cable for L91

UM0L911D = L91 User's Manual

ENTER KEY  4 seconds, 8 seconds

Press the scroll key for 4 seconds the display will enter the setup menu. Press this key for 8 seconds to enter the calibration mode.

UP KEY 

This key is used to increase the selected parameter value during the lock indicator is off.

DOWN KEY 

This key is used to decrease the selected parameter value during the lock indicator is off.

RESET KEY 

This key is used to:

- 1.Reset the limit condition after the process is within the limit.
- 2.Revert the display to the normal display.
- 3.Reset the latching alarm, once the alarm condition is removed.
- 4.Reset the limit annunciator.

Note: If the RESET key is left pressed, only ONE reset operation will occur. If the unit subsequently goes into a state where reset is required again, the RESET key (or remote reset contacts) must be released (opened) and pressed (closed) again.

UNLOCK KEY  4 seconds

Press the RESET key for 4 seconds to enable up/down key function, also to reset the reference data (**Section 3-13**) and the lock indicator will be extinguished. However, this function is disabled when remote lock is selected for EIFN (Event input function). **See section 3-11.**

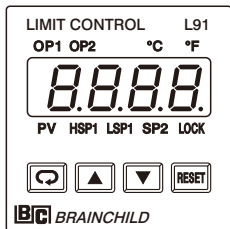

INDICATORS

Op1: Output 1 status indicator
OP2: Output 2 status indicator
°C: Degree C indicator
°F: Degree F indicator
PV: Process value
HSP1: High limit set point 1
LSP1: Low limit set point 1
SP2: Set point 2 for output 2
LOCK: Lock status indicator

Figure 1-2 Front Panel Display

DISPLAY FORM

Table 1-1 Display Form of Characters

A	<i>A</i>	E	<i>E</i>	I	<i>I</i>	N	<i>N</i>	S	<i>S</i>	X	
B	<i>b</i>	F	<i>F</i>	J	<i>J</i>	O	<i>O</i>	T	<i>t</i>	Y	<i>Y</i>
C	<i>C</i>	G	<i>G</i>	K	<i>K</i>	P	<i>P</i>	U	<i>u</i>	Z	
c	<i>c</i>	H	<i>H</i>	L	<i>L</i>	Q		V	<i>v</i>	?	<i>?</i>
D	<i>d</i>	h	<i>h</i>	M	<i>M</i>	R	<i>r</i>	W		=	<i>=</i>

▼: These characters are displayed differently.

How to display a 5-digit number :

For a number with decimal point the display will be shifted one digit right:

-199.99 will be displayed as -199.9, 4553.6 will be displayed as 4553

For a number without decimal point the display will be divided into two alternating phases:

-19999 will be displayed as:

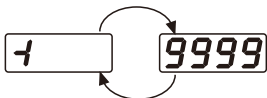

45536 will be displayed as:

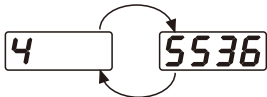

-9999 will be displayed as:

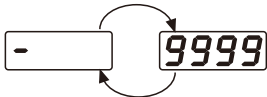

NORMAL DISPLAY

During normal operation, the unit can be configured to display the process value, high limit or low limit set point (HSP1 or LSP1 dependent on OUT1 selection) or the word SAFE.

ABNORMAL DISPLAY

Whenever the process is outside the normal range, the process value will be displayed.

SENSOR BREAK DISPLAY

If a break is detected in the sensor circuit, the display will show:

SEn.b Sbr.E

FW Version 22 & later, the display will change to *Sbr.E*

A-D FAILURE DISPLAY

If failure is detected in the A-D converter circuit, the display will show:

AdEr

POWER UP SEQUENCE

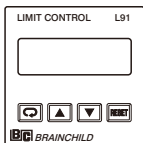

All segments of display and indicators are left off for 0.5 second.

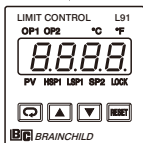

All segments of display and indicators are lit for 1 second.

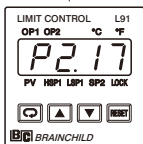

Display program code of the product for 1 second. The left diagram shows program no.2 with version 17.

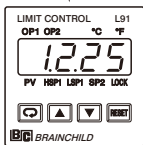

Display Date Code for 1 second. The left diagram shows Year 2001, Month February (2), Date 25'th. This means that the product is produced on February 25'th, 2001. Note that the month code **A** is for **October**, **B** is for **November** and **C** is for **December**.

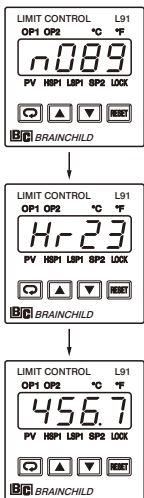

Display the serial number (001~999) for 1 second.

Display the hours used for 2 seconds. The left diagram shows that the unit has been used for 23456.7 hours since production.

Figure 1-3 Power Up Sequence

Verify all electrical connections have been properly made before applying power to the unit.

During power up, a self-test procedure is performed within 6.5 seconds. During self-test period all outputs are left off. When the self-test procedure is complete, the unit reverts to normal operation.

1-5 Menu Overview

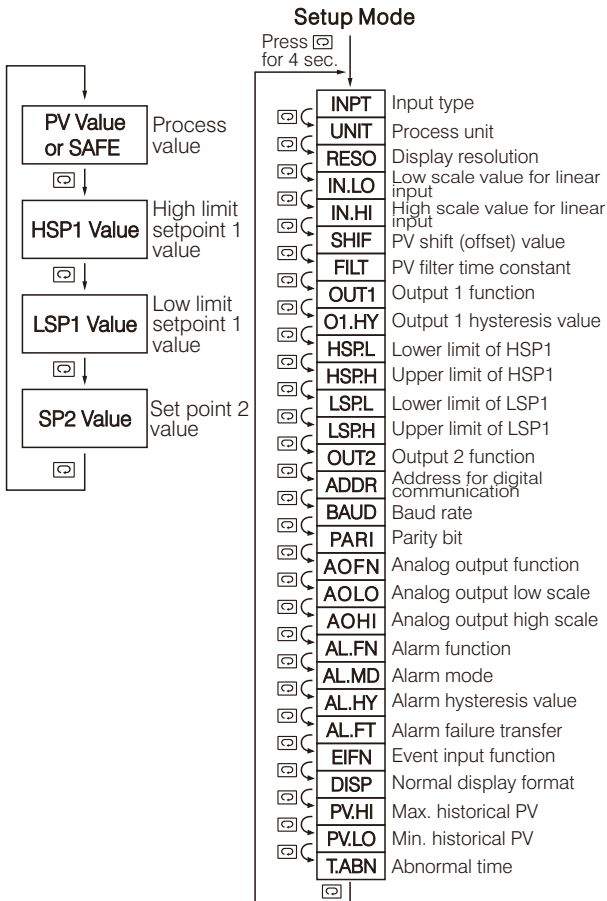

Note 1. The flow charts show a complete listing of parameters. For actual application the number of available parameters is dependent on the setup conditions, and should be less than that shown in the flow charts.

Note 2. Press  key for 4 seconds to enable up/down key function, and the LOCK indicator will be extinguished.

1-6 Limit Control Operation

HIGH LIMIT OPERATION

If Hi. is selected for OUT1, the unit will perform high limit control. When power is applied the OUT1 relay is de-energized. After 6.5 seconds self-test period, if the process is below the high limit set point (HSP1), the output 1 relay will be energized and OP1 indicator will go off. If the process goes above the high limit set point, the relay will be de-energized, the OP1 indicator will go on and the display will show the process value. After the process falls below the high limit set point and the RESET key is pressed or the remote reset input is applied, the relay will be energized and the OP1 indicator will go off.

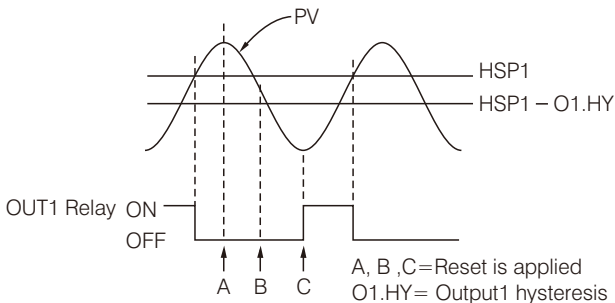

Figure 1-4 High Limit Operation

LOW LIMIT OPERATION

If Lo. is selected for OUT1, the unit will perform low limit control. When power is applied the OUT1 relay is de-energized. After 6.5 seconds self-test period, if the process is above the low limit set point (LSP1), the output 1 relay will be energized and OP1 indicator will go off. If the process goes below the low limit set point, the relay will be de-energized, the OP1 indicator will go on and the display will show the process value. After the process rises above the low limit set point and the RESET key is pressed or the remote reset input is applied, the relay will be energized and the OP1 indicator will go off.

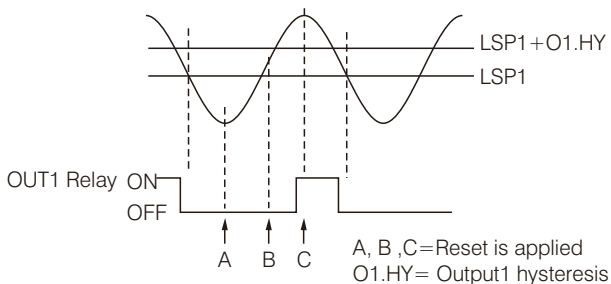

Figure 1-5 Low Limit Operation

HIGH/LOW LIMIT OPERATION

If Hi.Lo is selected for OUT1, the unit will perform high/low limit control. When power is applied the OUT1 relay is de-energized. After 6.5 seconds self-test period, if the process is below the high limit set point (HSP1) and above the low limit set point (LSP1), the output 1 relay will be energized and OP1 indicator will go off. If the process goes above the high limit set point or below the low limit set point, the relay will be de-energized, the OP1 indicator will go on and the display will show the process value. After the process is within the normal operation range, and the RESET key is pressed or the remote reset input is applied, the relay will be energized and the OP1 indicator will go off.

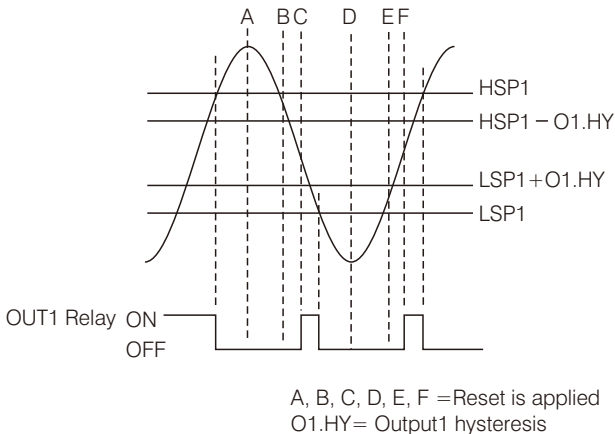

Figure 1-6 High/Low Limit Operation

1-7 Parameter Descriptions

Parameter Notation	Parameter Description	Range	Default Value
HSP1	High Limit Set point 1	Low: HSPL High: HSP.H	100.0 °C (212.0 °F)
LSP1	Low Limit Set point 1	Low: LSPL High: LSP.H	0 °C (32.0 °F)
SP2	Set point 2 Value for Output 2	Low: -19999 High: 45536	90.0 °C (194.0 °F)
INPT	Input Type Selection	0 <i>J_tC</i> : J type thermocouple 1 <i>K_tC</i> : K type thermocouple 2 <i>T_tC</i> : T type thermocouple 3 <i>E_tC</i> : E type thermocouple 4 <i>B_tC</i> : B type thermocouple 5 <i>R_tC</i> : R type thermocouple 6 <i>S_tC</i> : S type thermocouple 7 <i>N_tC</i> : N type thermocouple 8 <i>L_tC</i> : L type thermocouple 9 <i>C_tC</i> : C type thermocouple 10 <i>P_tC</i> : P type thermocouple 11 <i>PT100 DIN</i> : PT100 ohms DIN curve 12 <i>PT100 JIS</i> : PT100 ohms JIS curve	1 (0)

Parameter Notation	Parameter Description	Range	Default Value
INPT	Input Type Selection	13 $4-20$: 4~20 mA linear current 14 $0-20$: 0~20 mA linear current 15 $0-60$: 0~60 mV linear voltage 16 $0-1V$: 0~1 V linear voltage 17 $0-5V$: 0~5 V linear voltage 18 $1-5V$: 1~5 V linear voltage 19 $0-10$: 0~10V linear voltage	1 (0)
UNIT	Process Unit	0 $^{\circ}C$: Degree C unit 1 $^{\circ}F$: Degree F unit 2 P_u : Process unit	0 (1)
RESO	Display Resolution	0 $no.dP$: No decimal point 1 $1-dP$: 1 decimal point 2 $2-dP$: 2 decimal point 3 $3-dP$: 3 decimal point	1
IN.LO	Low Scale Value for Linear Input	Low: -19999 High: IN.HI	0

Parameter Notation	Parameter Description	Range	Default Value
IN.HI	High Scale Value for Linear Input	Low: IN.LO High: 45536	100.0
SHIF	PV Shift (offset) Value	Low: -200.0 °C (-360.0 °F) High: 200.0 °C (360.0 °F)	0.0
FILT	PV Filter Time Constant	0 0 : 0 second time constant 1 0.2 : 0.2 second time constant 2 0.5 : 0.5 second time constant 3 1 : 1 second time constant 4 2 : 2 seconds time constant 5 5 : 5 seconds time constant 6 10 : 10 seconds time constant 7 20 : 20 seconds time constant 8 30 : 30 seconds time constant 9 60 : 60 seconds time constant	2
OUT1	Output 1 Function	2 Hi : High limit control 3 Lo : Low limit control 4 Hi.Lo : High/Low limit control	2

Parameter Notation	Parameter Description	Range	Default Value
O1.HY	Output 1 Hysteresis Value	Low: 0.1 High: 10.0 °C (18.0 °F)	0.1
HSP.L	Lower Limit of HSP1	Low: -19999 High: HSP.H	0 °C (32.0 °F)
HSP.H	Upper Limit of HSP1	Low: HSP.L High: 45536	1000.0 °C (1832.0 °F)
LSP.L	Lower Limit of LSP1	Low: -19999 High: LSP.H	-100.0 °C (-148.0 °F)
LSP.H	Upper Limit of LSP1	Low: LSP.L High: 45536	0 °C (32.0 °F)
OUT 2	Output 2 Function	0 <i>nonE</i> : No function 1 <i>dCPS</i> : DC power supply output 2 <i>Coññ</i> : RS-485 Communication 3 <i>ALñ</i> : Alarm output 4 <i>L_Añ</i> : Limit annunciator 5 <i>EiFn</i> : Event input 6 <i>4-20</i> : 4-20mA analog retransmission output 7 <i>0-20</i> : 0-20mA analog retransmission output 8 <i>0-1V</i> : 0-1V analog retransmission output 9 <i>0-5V</i> : 0-5V analog retransmission output 10 <i>1-5V</i> : 1-5V analog retransmission output 11 <i>0-10</i> : 0-10V analog retransmission output	4
ADDR	Address Assignment of Digital COMM	Low: 1 High: 255	1
BAUD	Baud Rate of Digital COMM	0 <i>0.3</i> : 0.3 Kbits/s baud rate 1 <i>0.6</i> : 0.6 Kbits/s baud rate	

Parameter Notation	Parameter Description	Range	Default Value
BAUD	Baud Rate of Digital COMM	2 12 : 1.2 Kbits/s baud rate 3 24 : 2.4 Kbits/s baud rate 4 48 : 4.8 Kbits/s baud rate 5 96 : 9.6 Kbits/s baud rate 6 144 : 14.4 Kbits/s baud rate 7 192 : 19.2 Kbits/s baud rate 8 288 : 28.8 Kbits/s baud rate 9 384 : 38.4 Kbits/s baud rate	5
PARI	Parity Bit of Digital COMM	0 EVEN : 8 bit even parity 1 odd : 8 bit odd parity 2 none : 8 bit none parity	0
AOFN	Analog Output Function	0 PU : Process value 1 HSP1 : High Limit Set point 1 2 LSP1 : Low Limit Set point 1	0
AOLO	Analog Output Low Scale Value	Low: -19999 High: 45536	0 °C (32.0 °F)
AOHI	Analog Output High Scale Value	Low: -19999 High: 45536	100.0 °C (212.0 °F)
AL.FN	Alarm function	6 PYHA : Process value high alarm 7 PYLA : Process value low alarm	6

Parameter Notation	Parameter Description	Range	Default Value
AL.MD	Alarm mode	0 <i>no r n̄</i> : Normal alarm action 1 <i>l t c h</i> : Latching alarm action	0
AL.HY	Alarm hysteresis value	Low: 0.1 High: 10 °C (18.0 °F)	0.1
AL.FT	Alarm failure transfer	0 <i>o f f</i> : Alarm output goes off as unit fails 1 <i>o n</i> : Alarm output goes on as unit fails	1
EIFN	Event input function	0 <i>no n E</i> : No event function 1 <i>r E S E t</i> : Remote reset for output 1, output 1 on. 2 <i>L o c k</i> : Remote lock for the unit	0
DISP	Normal display format	0 <i>P V</i> : Display process value 1 <i>S P I</i> : Display HSP1 or LSP1 value 2 <i>S A F E</i> : Display the word SAFE	0
PV.HI	Historical Max. value of PV	Low: -19999 High: 45536	—
PV.LO	Historical Min. value of PV	Low: -19999 High: 45536	—
T.ABN	Accumulated time during abnormal condition	Low: 0 High: 6553.5 minutes	—

Chapter 2 Installation

 Dangerous voltages capable of causing death are sometimes present in this instrument. Before installation or beginning any troubleshooting procedures the power to all equipment must be switched off and isolated. Units suspected of being faulty must be disconnected and removed to a properly equipped workshop for testing and repair. Component replacement and internal adjustments must be made by a qualified maintenance person only.

 To minimize the possibility of fire or shock hazards, do not expose this instrument to rain or excessive moisture.

 Do not use this instrument in areas under hazardous conditions such as excessive shock, vibration, dirt, moisture, corrosive gases or oil. The ambient temperature of the areas should not exceed the maximum rating specified in Chapter 6.

2 - 1 Unpacking

Upon receipt of the shipment remove the unit from the carton and inspect the unit for shipping damage. If any damage due to transit, report and claim with the carrier. Write down the model number, serial number, and date code for future reference when corresponding with our service center. The serial number (S/N) and date code (D/C) are labeled on the box and the housing of the unit.

2 - 2 Mounting

Make panel cutout to dimension shown in Figure 2-1.

Install both mounting clamps and insert the housing into panel cutout.

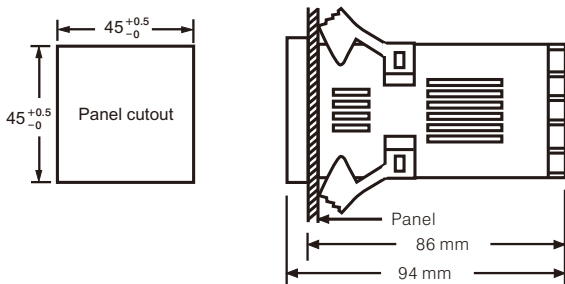

Figure 2-1 Mounting Diagram

2 - 3 Wiring Precautions

- ★ Before wiring, verify the label for correct model number and options. Switch off the power when checking.
- ★ Care must be taken to ensure that maximum voltage rating specified on the label are not exceeded.
- ★ It is recommended that power of these units to be protected by fuses or circuit breakers rated at the minimum value possible.
- ★ All units should be installed inside a suitably grounded metal enclosure to prevent live parts being accessible from human hands and metal tools.
- ★ All wiring must conform to appropriate standards of good practice and local codes and regulations. Wiring must be suitable for maximum voltage, current, and temperature rating of the system.
- ★ Beware not to over-tighten the terminal screws. The torque should not exceed 1.14 N-m (10 Lb-in or 11.52 KgF-cm), temperature Min. 60°C, use copper conductors only.

- ★ Unused control terminals should not be used as jumper points as they may be internally connected, causing damage to the unit.
- ★ Verify that the ratings of the output devices and the inputs as specified in Chapter 6 are not exceeded.
- ★ Electric power in industrial environments contains a certain amount of noise in the form of transient voltage and spikes. This electrical noise can enter and adversely affect the operation of microprocessor-based controls. For this reason we strongly recommend the use of shielded thermocouple extension wire which connects the sensor to the unit. This wire is a twisted-pair construction with foil wrap and drain wire. The drain wire is to be attached to earth ground at the sensor end only.
- ★ Except the thermocouple wiring, all wiring should use stranded copper conductor with maximum gauge 18 AWG.

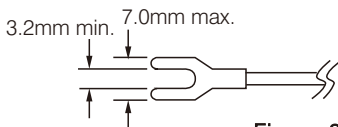

Figure 2-2 Lead Termination

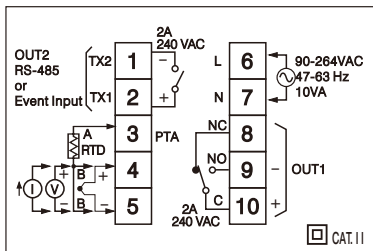

Figure 2-3 Rear Terminal Connection Diagram

2-4 Power Wiring

The unit is supplied to operate at 11-26 VAC / VDC or 90-264VAC. Check that the installation voltage corresponds with the power rating indicated on the product label before connecting power to the unit.

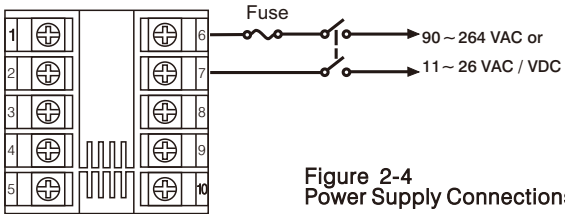

Figure 2-4
Power Supply Connections



This equipment is designed for installation in an enclosure which provides adequate protection against electric shock. The enclosure must be connected to earth ground.

Local requirements regarding electrical installation should be rigidly observed. Consideration should be given to prevent from unauthorized person access to the power terminals.

2-5 Sensor Installation Guidelines

Proper sensor installation can eliminate many problems in a control system. The probe should be placed so that it can detect any temperature change with minimal thermal lag. In a process that requires fairly constant heat output, the probe should be placed closed to the heater. In a process where the heat demand is variable, the probe should be closed to the work area. Some experiments with probe location are often required to find this optimum position.

In a liquid process, addition of a stirrer will help to eliminate thermal lag. Since the thermocouple is basically a point measuring device, placing more than one thermocouple in parallel will provide an average temperature readout and produce better results in most air heated processes.

Proper sensor type is also a very important factor to obtain precise measurements. The sensor must have the correct temperature range to meet the process requirements. In special processes the sensor might need to have different requirements such as leak-proof, anti-vibration, antiseptic, etc.

Standard thermocouple sensor limits of error are ± 4 degrees F (± 2 degrees C) or 0.75% of sensed temperature (half that for special) plus drift caused by improper protection or an over-temperature occurrence. This error is far greater than controller error and cannot be corrected at the sensor except by proper selection and replacement.

2-6 Thermocouple Input Wiring

Thermocouple input connections are shown in Figure 2-5. The correct type of thermocouple extension lead-wire or compensating cable must be used for the entire distance between the unit and the thermocouple, ensuring that the correct polarity is observed throughout. Joints in the cable should be avoided, if possible.

If the length of thermocouple plus the extension wire is too long, it may affect the temperature measurement. A 400 ohms K type or a 500 ohms J type thermocouple lead resistance will produce approximately 1 degree C temperature error .

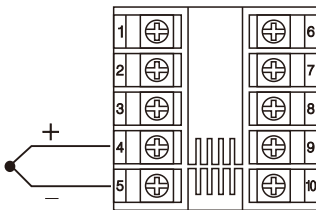

Figure 2.5
Thermocouple Input Wiring

2-7 RTD Input Wiring

RTD connection are shown in Figure 2-6, with the compensating lead connected to terminal 4. For two-wire RTD inputs, terminals 4 and 5 should be linked. The three-wire RTD offers the capability of lead resistance compensation provided that the three leads are of same gauge and equal length.

Two-wire RTD should be avoided, if possible, for the purpose of accuracy. A 0.4 ohm lead resistance of a two-wire RTD will produce 1 degree C temperature error.

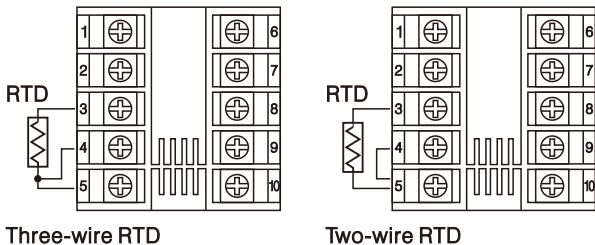

Figure 2-6
RTD Input Wiring

2-8 Linear DC Input Wiring

DC linear voltage and linear current connections are shown in Figure 2-7 and Figure 2-8 .

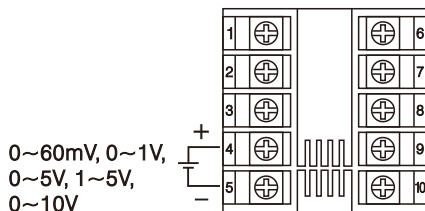

Figure 2.7
Linear Voltage Input Wiring

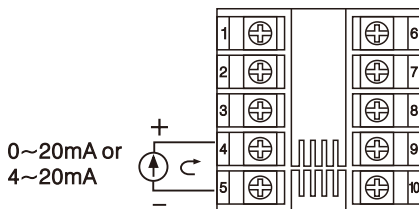

Figure 2.8
Linear Current Input Wiring

2-9 Event Input wiring

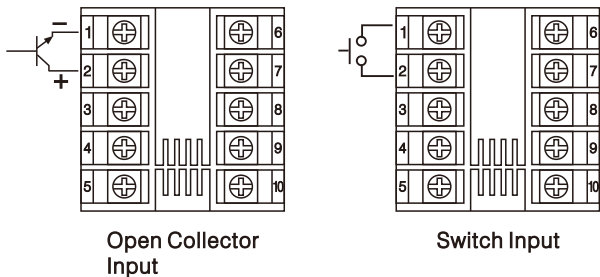
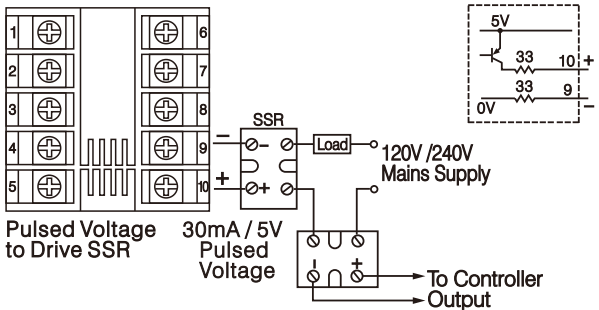
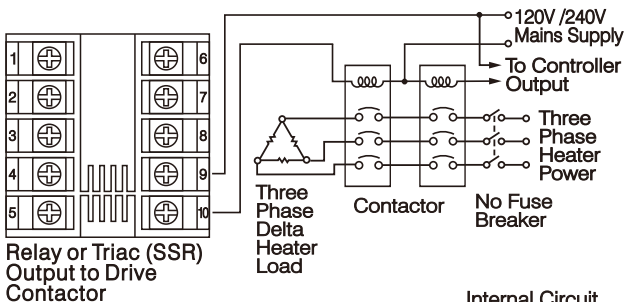
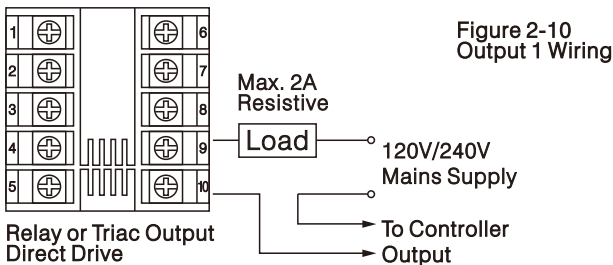

Figure 2-9
Event Input Wiring

The event input can accept a switch signal as well as an open collector signal. The event input function (EIFN) is activated as the switch is closed or an open collector (or a logic signal) is pulled down.

2-10 Output 1 Wiring



2-11 Output 2 Wiring

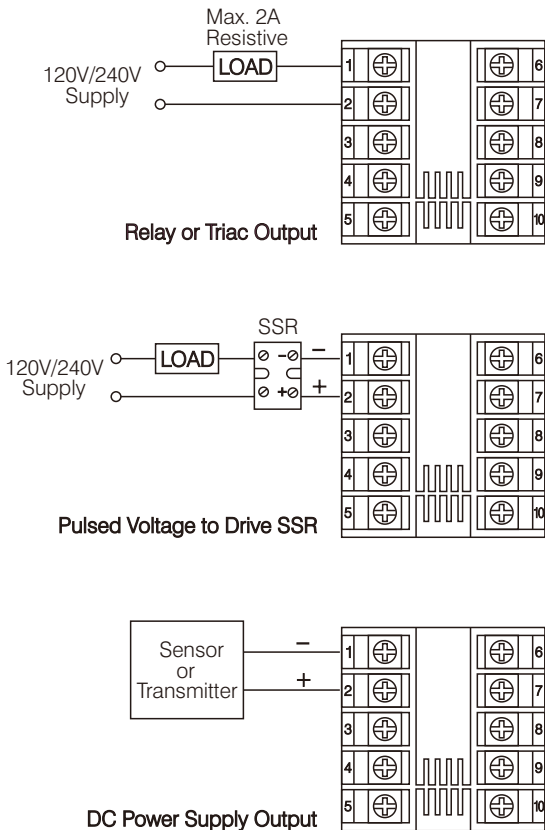

Figure 2-11 Output 2 Wiring

2-12 RS-485

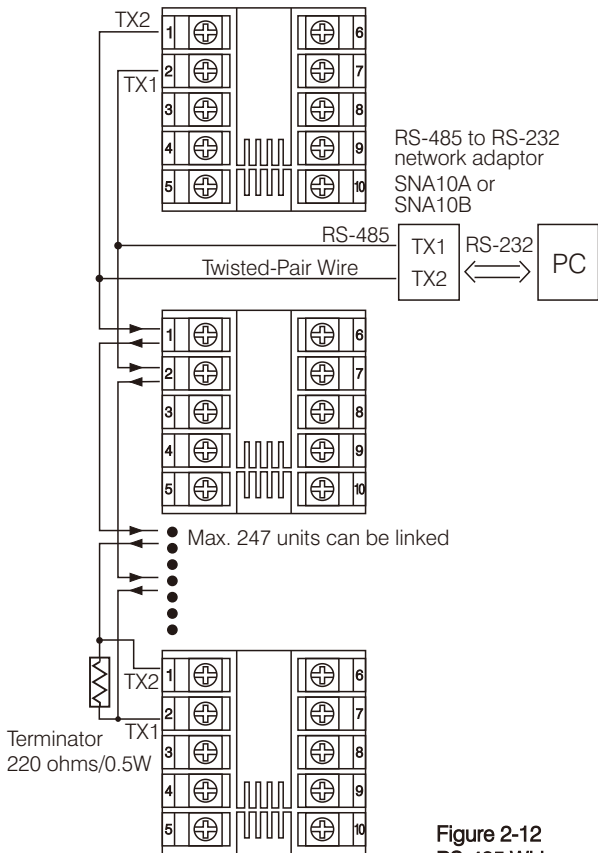

Figure 2-12
RS-485 Wiring

Formula: $PV = IN.LO + (IN.HI - IN.LO) \frac{S-SL}{SH-SL}$

Example: a 4-20 mA current loop pressure transducer with range 0 - 15 kg/cm², is connected to input, then perform the following setup:

INPT = 4-20 mA IN.LO = 0.0
UNIT = PU IN.HI = 15.0
RESO = 1-DP

Of course, you may select other value for RESO to alter the resolution.

3-2 Limit Control

OUT1: Selects the output 1 function. The available output 1 functions are: High Limit Control, Low Limit Control and High/Low Limit Control. Refer to **Section 1-6** for the limit control operation.

O1.HY: Output 1 hysteresis value. The hysteresis value is adjusted to a proper value to eliminate the relay jitter in a noisy environment.

3-3 Set Point Range

HSPL : Lower limit of HSP1
Hidden if LO is selected for OUT1

HSPH : Upper limit of HSP1
Hidden if LO is selected for OUT1



LSPL : Lower limit of LSP1
Hidden if HI is selected for OUT1

LSPH : Upper limit of LSP1
Hidden if HI is selected for OUT1

HSPL and HSPH in setup menu are used to confine the adjustment range of HSP1. LSPL and LSPH are used to confine the adjustment range of LSP1.

Chapter 3 Programming

3-1 Process Input

Press  for 4 seconds to enter setup mode. Press  to select parameter. The display will indicate the parameter symbol and the

INPT: Selects the sensor type and signal type for the process input.

UNIT: Selects the process unit.

RESO: Selects the location of the decimal point (Resolution) for most (not all) process related parameters.

IN.LO: Selects the low scale value for the Linear type input
Hidden if: T/C or RTD type is selected for INPT

IN.HI: Selects the high scale value for the Linear type input
Hidden if: T/C or RTD type is selected for INPT

How to use IN.LO and IN.HI:

If 4-20mA is selected for INPT, let SL specifies the input signal low (ie. 4mA), SH specifies the signal high (ie. 20mA), S specifies the current input signal value, the conversion

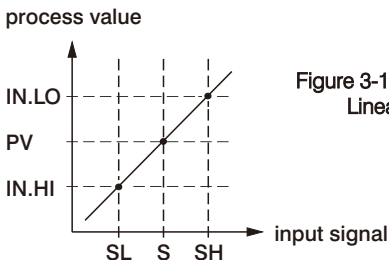

Figure 3-1 Conversion Curve for Linear Type Process Value

3-4 PV Shift

In certain application it is desirable to shift the indicated value from its actual value. This can be easily accomplished

Cycle the unit to the SHIF parameter by using the scroll key. The number you adjust here, either positive or negative, will

SHIF: PV shift (offset) value

3-5 Digital Filter

In certain applications the process value is too unstable to be read. To Improve this a programmable low pass filter incorporated in the L91 can be used. This is a first order filter with time constant specified by FILT parameter which is contained in setup menu. The FILT is defaulted to 0.5 sec. before shipping. Adjust FILT to change the time constant from 0 to 60 seconds. 0 second represents no filter is applied to the input signal. The filter is

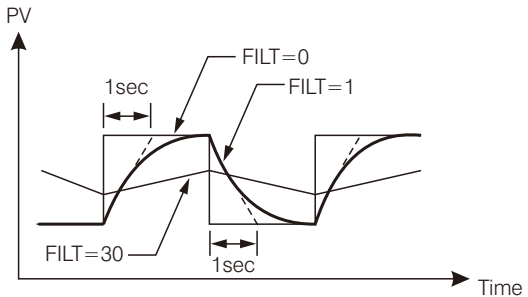

Figure 3-2 Filter Characteristics

3-6 Process Alarms

The output 2 will perform process alarm function by selecting ALM for OUT2 and PV.H.A or PV.L.A for AL.FN. If PV.H.A is selected the alarm will perform process high alarm. If PV.L.A is selected the alarm will perform process low alarm. The process alarm sets an absolute trigger level. When the process exceeds that absolute trigger level an alarm occurs. The trigger level is determined by SP2 (Set point 2 value) and AL.HY (Alarm hysteresis value). The hysteresis value is introduced to avoid interference action of alarm in a noisy

Trigger levels for process high alarm are SP2 and SP2 AL.HY.

There are two types of alarm mode can be selected, these are: normal alarm and latching alarm.

Normal Alarm: AL.MD= NORM

When a normal alarm is selected, the alarm output is de-energized in

Latching Alarm: AL.MD= LTCH

If a latching alarm is selected, once the alarm output is energized, it will remain unchanged even if the alarm condition has been cleared unless the power is shut off or

Failure Transfer: AL.FT = OFF or ON

In case of **Sensor Break** or **A-D Failure** occurs, the alarm

Examples:

SP2 = 200

AL.HY = 10.0

AL.MD = NORM

AL.FN = PV.H.A

Select COMM for OUT2 in setup menu, the output 2 will perform RS-485 interface with **Modbus RTU Mode** protocol.

Setup

1. Select COMM for OUT2
2. Set an unequal address (ADDR) for those units which are connected to the same port.
3. Set the Baud Rate (BAUD) and Parity Bit (PARI) such that these values are accordant with PC setup conditions.

3-8 Display Mode

The DISP in the setup menu is used to select the display format for the normal condition. If PV is selected, the display will indicate the process value. If SP1 is selected, the display will indicate HSP1 value for high limit control (OUT1= HI) and high/low limit control (OUT1= HI.LO) or indicate LSP1 value for low limit control(OUT1=LO). IF SAFE is selected, the

However the display will indicate the process value if the process value goes beyond high limit or low limit. If an error

3-9 Signal Conditioner DC Power Supply

Three types of isolated DC power supply are available to supply an external transmitter or sensor. These are 20V rated at 25mA, 12V rated at 40 mA and 5V rated at 80 mA. The DC voltage is delivered to

Examples:

Process proceeds
→

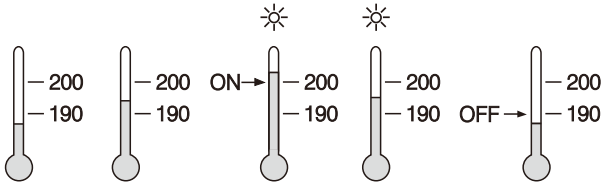

Figure 3.3
Normal Process Alarm

SP2 = 200
AL.MD = LTCH

AL.HY = 10.0
AL.FN = PV.H.A

Process proceeds
→

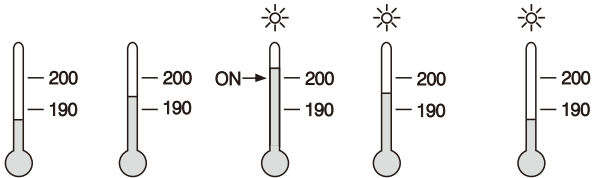
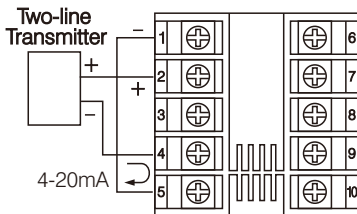

Figure 3.4
Latching Process Alarm

3-7 RS-485 Communication

Using a PC for data communication is the most economic way. The signal is transmitted and received through the PC communication Port (generally RS-232). Since a standard PC can't support RS-485 port, a network adaptor (such as SNA10A, SNA10B) has to be used to convert RS-485 to RS-232 for a PC if RS-485 is required for the data communication. Many RS-485 units (up to 247 units) can be connected to one RS-232, that is a



Set
OUT2 = dCPS
 DC Power Supply

Figure 3-5
 DC Power Supply
 Application

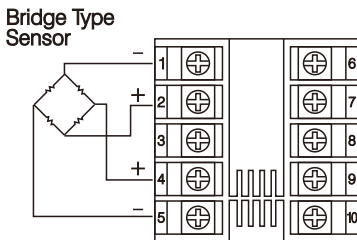
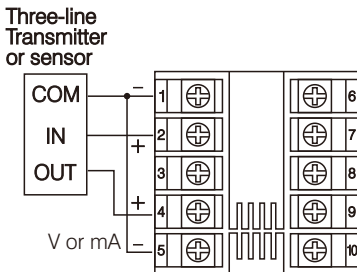

Caution:

Don't use the DC power supply beyond its rating current to avoid damage.

Purchase a correct voltage to suit your external devices. See ordering code in section 1-2.

3-10 Remote Reset

If EIFN is selected for OUT2 and REST is selected for EIFN, terminals 1 & 2 will act as remote reset input. Pressing remote reset button will perform the same function as pressing the

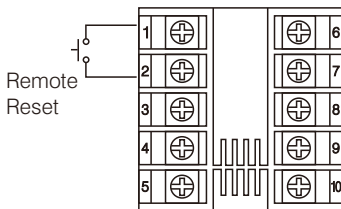

Setup

OUT2 = EIFN

EIFN = REST

Figure 3-6 Remote Reset Application

3-11 Remote Lock

If EIFN is selected for OUT2 and LOCK is selected for EIFN, terminals 1 & 2 will act as remote lock input. Turning the remote

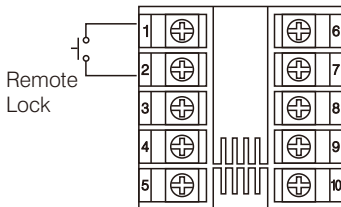

Setup

OUT2 = EIFN

EIFN = LOCK

Figure 3-7 Remote Lock Application

3-12 Limit Annunciator

If L_AN (Limit annunciator) is selected for OUT2, the output 2 will act as a Limit Annunciator. If the limit is or has been reached and the RESET key (or remote reset contacts) has not been pressed since the limit was reached, then the limit annunciator output will be energized and the OP2 indicator will be lit and remain

3-13 Reference Data

There are three reference data contained in setup menu. The reference data are read only data. The maximum historical PV, displayed by $P_{U.H}$, which shows the maximum process value since the last UNLOCK operation. The minimum historical PV, displayed by $P_{U.L}$, which shows the minimum process value since the last UNLOCK operation. The abnormal time, displayed by $t_{A.B.N}$, which shows the total accumulated time (minutes) during the process has been in abnormal condition since the last UNLOCK operation.

The values of reference data will be initiated as soon as the RESET key is pressed for 4 seconds (UNLOCK operation).

Chapter 4 Application

An oven uses a single phase heater to heat the process. A single loop temperature control C91 is used to regulate the temperature. A limit control L91 is used to protect the process from being over

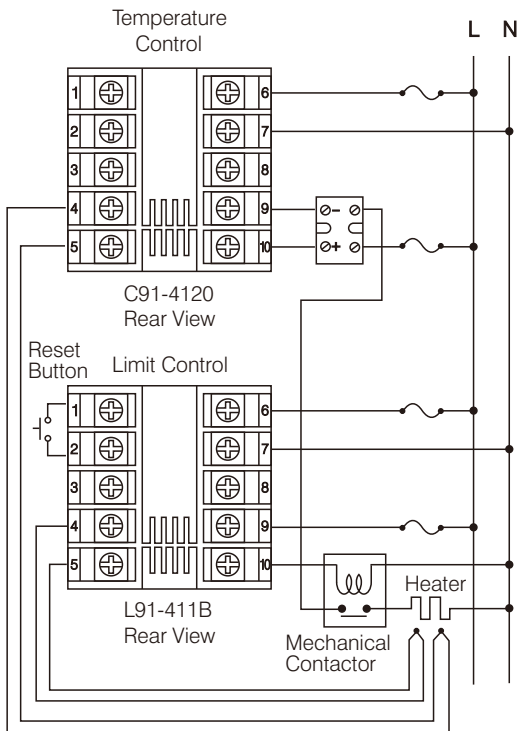

Figure 4-1 Over Temperature Protection with Remote Reset

Chapter 5 Calibration

⚠ Do not proceed through this section unless there is a definite need to re-calibrate the controller. Otherwise, all previous calibration data will be lost. Do not attempt re-calibration unless you have appropriate calibration equipment. If calibration data is lost, you will need to return the unit to your supplier who may

⚠ Entering calibration mode will break the control loop. Make sure that if the system is allowable to apply calibration mode.

Equipments needed for calibration:

- (1) A high accuracy calibrator (Fluck 5520A Calibrator recommended) with following function:
 - 0-100mA millivolt source with $\pm 0.005\%$ accuracy
 - 0-10V voltage source with $\pm 0.005\%$ accuracy
 - 0-20mA current source with $\pm 0.005\%$ accuracy
 - 0-300 ohm resistant source with $\pm 0.005\%$ accuracy
- (2) A test chamber providing 25 °C - 50°C temperature range
- (3) A switching network (SCANNER 80, optional for automatic calibration)
- (4) A calibration fixture equipped with programming units (optional for automatic calibration)
- (5) A PC with calibration software BC-Net and Smart Network Adaptor SNA10B (optional for automatic calibration)

Since each unit needs 30 minutes to warm up before calibration, calibrating one unit each is inefficient. An automatic calibration system for small quantity well as for unlimited quantity is available upon request.

The calibration procedures described in the following are a step by step **manual procedures**.

Apply Enter Key (press  for 8 seconds) to enter the calibration mode. see **Figure 5-1**.

Figure 5-1
Flow Chart for Manual
Calibrator

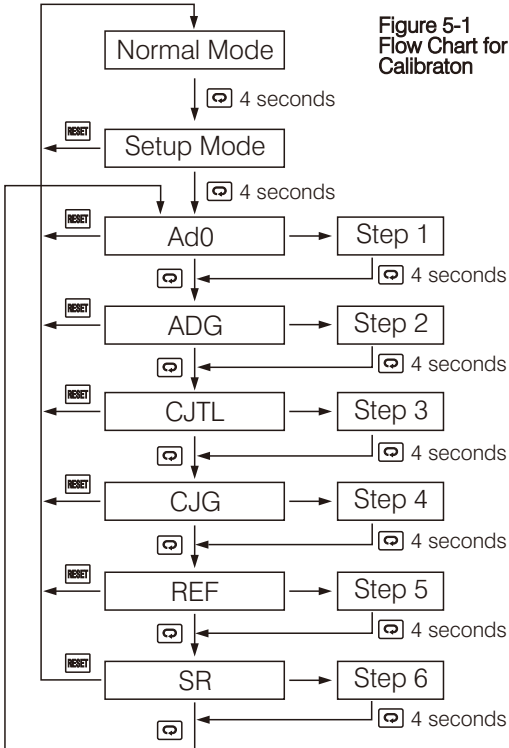

Step1: Calibrate **Zero** of A to D converter.

Short terminal 4 and 5, then press  for at least 4 seconds. The display will blink a moment. If the display didn't blink, then the calibration fails.

Step 2: Calibrate **Gain** of A to D converter.

Send a span signal to terminal 4 and 5 with correct polarity. The span signal is 60 mV for thermocouple input, 1V for 0-1V input, 10V for 0-10V input and 20mA for 0-20 mA input. Press  for at least 4 seconds. The display will blink a moment. If the display didn't blink, then the calibration fails.

Step 3: Calibrate **offset** of cold junction.

Setup the equipment according to the following diagram for calibrating the cold junction compensation. Note that a K type thermocouple must be used.

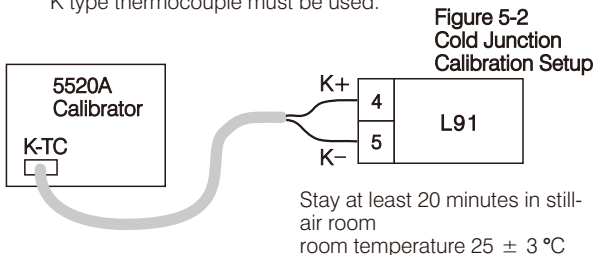

The 5520A calibrator is configured as K type thermocouple output with internal compensation. Send a $0.00 \text{ }^{\circ}\text{C}$ signal to the unit under calibration.

The unit under calibration is powered in a still-air room with temperature **$25 \pm 3 \text{ }^{\circ}\text{C}$** . Stay at least 20 minutes for warming. Press  for at least 4 seconds. The display will blink a moment.

Step 4: Calibrate **gain of cold junction**.

Setup the equipment same as step 3. The unit under calibration is power in a still-air room with temperature 50 ± 3 °C. Stay at least 20 minutes for warming up. The calibrator source is set at 0.00 °C with internal compensation mode. Press  for at least 4 seconds. The display will blink a moment. If the display didn't blink, then the calibration fails.

Step 5: Calibrate **RTD reference voltage**.

Send a 100 ohms signal to terminal 3, 4 and 5 according to **Figure 5-3**.

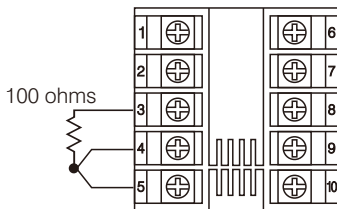



Figure 5-3
RTD Calibration

Press  for at least 4 seconds. The display will blink a moment. If the display didn't blink, then the calibration fails.

Step 6: Calibrate **RTD serial resistance**.

Change the ohm's value of the calibrator to 300 ohms. Press  for at least 4 seconds. The display will blink a moment. If the display didn't blink, then the calibration fails.

★ **Input modification** and **recalibration** procedures for a **linear voltage** or a **linear current** input:

1. Remove R61(1.8K) and install two 1/4 W resistors RA and RB on the control board with the recommended values specified in the following table.
The low temperature coefficient resistors with $\pm 1\% \pm 50\text{ppm}$ should be used for RA and RB.

Input Function	RA	RB	R61
T/C, RTD, 0~60mV	X	X	1.8K
0 ~ 1 V	61.9K	3.92K	X
0 ~ 5V, 1 ~ 5V	324K	3.92K	X
0 ~ 10 V	649K	3.92K	X
0~20mA, 4~20mA	39 Ω	3.01 Ω	X

2. Perform **Step 1** to calibrate the linear input zero.
3. Perform **Step 2** but send a span signal to the input terminals instead of 60mV. The span signal is 1V for 0~1V input, 5V for 0~5V or 1~5V input, 10V for 0~10V input and 20mA for 0~20mA or 4~20mA input.

Chapter 6 Specifications

Power

90-264 VAC, 47-63 Hz, 10 VA, 5W maximum

11-26 VAC/VDC, SELV, Limited Energy, 10 VA, 5W maximum

Input

Resolution: 18 bits

Sampling: 5 times/second

Maximum Rating: -2 VDC minimum, 12 VDC maximum
(1 minute for mA input)

Temperature Effect: $\pm 1.5 \mu\text{V} / ^\circ\text{C}$

Sensor Lead Resistance Effect:

T/C: 0.2 $\mu\text{V}/\text{ohm}$

3-wire RTD: 2.6 $^\circ\text{C}/\text{ohm}$ of resistance difference of two leads

2-wire RTD: 2.6 $^\circ\text{C}/\text{ohm}$ of resistance sum of two leads

Burn-out Current: 200nA

Common Mode Rejection Ratio (CMRR): 120db

Sensor Break Detection:

Sensor open for TC, RTD and mV inputs,
below 1 mA for 4-20 mA input,
below 0.25V for 1-5 V input,
unavailable for other inputs.

Sensor Break Responding Time:

Within 4 seconds for TC, RTD and mA inputs,
0.1 second for 4-20 mA and 1-5V inputs.

Characteristics:

Type	Range	Accuracy @ 25 °C	Input Impedance
J	-120°C-1000°C (-184°F-1832°F)	±2 °C	2.2 MΩ
K	-200°C-1370°C (-328°F-2498°F)	±2 °C	2.2 MΩ
T	-250°C-400°C (-418°F-752°F)	±2 °C	2.2 MΩ
E	-100°C-900°C (-148°F-1652°F)	±2 °C	2.2 MΩ
B	0°C-1820°C (-32°F-3308°F)	±2 °C (200°C- 1820°C)	2.2 MΩ
R	0°C-1767.8°C (-32°F-3214°F)	±2 °C	2.2 MΩ
S	0°C-1767.8°C (-32°F-3214°F)	±2 °C	2.2 MΩ
N	-250°C-1300°C (-418°F-2372°F)	±2 °C	2.2 MΩ
L	-200°C-900°C (-328°F-1652°F)	±2 °C	2.2 MΩ
PT100 (DIN)	-210°C-700°C (-346°F-1292°F)	±0.4 °C	1.3 KΩ
PT100 (JIS)	-200°C-600°C (-328°F-1112°F)	±0.4 °C	1.3 KΩ
mV	-8mV - 70mV	±0.05 %	2.2 MΩ
mA	-3mA-27mA	±0.05 %	100 Ω
V	-1.3V-11.5V	±0.05 %	510 KΩ

Table 6-1 Input Characteristics

Event Input

Logic Low: -10V minimum, 0.8V maximum.

Logic High: 2V minimum, 10V maximum.

Functions: Remote reset, remote lockout.

Output 1 / Output 2

Relay Rating: 2A/240 VAC, life cycles 200,000 for resistive load.

Pulsed Voltage: Source Voltage 5V, current limiting resistance 66 ohms.

Triac (SSR) Output

Rating: 1A/240 VAC

Inrush Current: 20A for 1 cycle

Min. Load Current: 50 mA rms

Max. Off-state Leakage: 3 mA rms

Max. On-state Voltage: 1.5 V rms

Insulation Resistance: 1000 Mohms min. at 500 VDC

Dielectric Strength: 2500 VAC for 1 minute

DC Voltage Supply Characteristics (Installed at Output 2)

Type	Tolerance	Max. Output Current	Ripple Voltage	Isolation Barrier
20 V	± 1 V	25 mA	0.2 Vp-p	500 VAC
12 V	± 0.6 V	40 mA	0.1 Vp-p	500 VAC
5 V	± 0.25 V	80 mA	0.05 Vp-p	500 VAC

Data Communication

Interface : RS-485 (up to 247 units)

Protocol : Modbus Protocol RTU mode

Address : 1 - 247

Baud Rate : 0.3 ~ 38.4 Kbits/sec

Data Bits : 8 bits

Parity Bit : None, Even or Odd

Stop Bit : 1 or 2 bits

Communication Buffer : 50 bytes

User Interface

4-digit LED Displays: 0.4" (10mm),

keypad: 4 keys

Programming Port: For automatic setup, calibration and testing.

Communication Port: Connection to PC for supervisory control.

Limit Control: High Limit, Low limit and High/Low Limit programmable

Digital Filter

Function: First order

Time Constant: 0, 0.2, 0.5, 1, 2, 5, 10, 20, 30, 60 seconds programmable

Environmental & Physical

Operating Temperature : -10 °C to 50 °C

Storage Temperature : -40 °C to 60 °C

Humidity : 0 to 90 % RH (non-condensing)

Insulation Resistance : 20 Mohms min. (at 500 VDC)

Dielectric Strength : 2000 VAC, 50/60 Hz for 1 minute

Vibration Resistance : 10 - 55 Hz, 10 m/s² for 2 hours

Shock Resistance : 200 m/s² (20 g)

Moldings : Flame retardant polycarbonate

Dimensions: 48 mm(W) X 48 mm(H) X 94 mm(D),
86 mm depth behind panel

Weight : 150 grams

Approval Standards

Safety : UL 61010-1, 3rd Edition.

CAN/CSA-C22.2 No. 61010-1(2012-05), 3rd Edition.

Protective Class :

IP30 front panel, indoor use,

IP 20 housing and terminals (with protective cover)

EMC EN61326

Chapter 7 Modbus Communications

This chapter specifies the Modbus Communications protocol as RS-232 or RS-485 interface module is installed. Only RTU mode is supported. Data is transmitted as eight-bit binary bytes with 1 start bit, 1 stop bit and optional parity checking (None, Even or Odd). Baud rate may be set to 300, 600, 1200, 2400, 4800, 9600, 14400, 19200, 28800 and 38400.

7-1 Functions Supported

Only function 03, 06 and 16 are available for this series of controllers. The message formats for each function are described as follows:

Function 03: Read Holding Registers

Query (from master)	Response (from slave)
Slave address (0-255)	←
Function code (3)	←
Starting address of register Hi (0)	Byte count
Starting address of register Lo (0-61, 128-143)	Data 1 Hi
	Data 1 Lo
No. of words Hi (0)	Data 2 Hi
No. of words Lo (1-22)	Data 2 Lo
CRC16 Hi	⋮
CRC16 Lo	⋮
	CRC16 Hi
	CRC16 Lo

Function 06: Preset single Register

Query (from master)	Response (from slave)
Slave address (0-255)	←
Function code (6)	←
Register address Hi (0)	←
Register address Lo (0-61, 128-143)	←
Data Hi	←
Data Lo	←
CRC16 Hi	←
CRC16 Lo	←

Function 16: Preset Multiple Registers

Query (from master)	Response (from slave)
Slave address (0-255)	←
Function code (16)	←
Starting address of register Hi (0)	←
Starting address of register Lo (0-61, 128-143)	←
No. of words Hi (0)	←
No. of words Lo (1-18)	←
Byte count (2-36)	CRC16 Hi
Data 1 Hi	CRC16 Lo
Data 1 Lo	
Data 2 Hi	
Data 2 Lo	
•	
•	
•	
•	
CRC16 Hi	
CRC16 Lo	

7-2 Exception Responses

If the controller receives a message which contains a corrupted character (parity check error, framing error etc.), or if the CRC16 check fails, the controller ignores the message.

However, if the controller receives a syntactically correct message which contains an illegal value, it will send an exception response, consisting of five bytes as follows:

slave address + offset function code + exception code + CRC16 Hi + CRC16 Lo

Where the offset function code is obtained by adding the function code with 128 (ie. function 3 becomes H'83), and the exception code is equal to the value contained in the following table:

Exception Code	Name	Cause
1	Bad function code	Function code is not supported by the controller
2	Illegal data address	Register address out of range
3	Illegal data value	Data value out of range or attempt to write a read-only or protected data

7-3 Parameter Table

Register Address	Parameter Notation	Parameter	Scale Low	Scale High	Notes
0		Reserved			
1	HSP1	High limit set point 1	*1	*1	R/W
2	LSP1	Low limit set point 1	*1	*1	R/W
3	SP2	Set point 2 value for output 2	*1	*1	R/W
4		Reserved			
5		Reserved			
6	PV.HI	Historical max. value of PV	*1	*1	R
7	PV.LO	Historical min. value of PV	*1	*1	R
8		Reserved			
9	INPT	Input type selection	0	65535	R/W
10	UNIT	Process unit	0	65535	R/W
11	RESO	Display resolution	0	65535	R/W
12	IN.LO	Low scale value for linear input	*1	*1	R/W
13	IN.HI	High scale value for linear input	*1	*1	R/W
14	SHIF	PV shift (offset) value	*1	*1	R/W
15	FILT	PV filter time constant	0	65535	R/W
16	T.ABN	Accumulated time during abnormal condition	0	6553.5	R
17	OUT1	Output 1 function	0	65535	R/W
18		Reserved			
19		Reserved			
20	O1.HY	Output 1 hysteresis value	*2	*2	R/W
21		Reserved			
22		Reserved			
23		Reserved			
24		Reserved			
25		Reserved			
26		Reserved			
27		Reserved			
28	HSPL	Lower limit of HSP1	*1	*1	R/W
29	HSPH	Upper limit of HSP1	*1	*1	R/W

Register Address	Parameter Notation	Parameter	Scale Low	Scale High	Notes
30	L SPL	Lower limit of LSP1	*1	*1	R/W
31	L SPH	Upper limit of LSP1	*1	*1	R/W
32		Reserved			
33		Reserved			
34	A OFN	Analog output function	0	65535	R/W
35	O UT2	Output 2 function	0	65535	R/W
36		Reserved			
37		Reserved			
38		Reserved			
39		Reserved			
40	A DD R	Address	0	65535	R/W
41	B AUD	Baud rate	0	65535	R/W
42	P AR I	Parity bit	0	65535	R/W
43		Reserved			
41		Reserved			
43	A OLO	Analog output scale low	*1	*1	R/W
44	A L.FN	Alarm function	0	65535	R/W
45	A L.MD	Alarm mode	0	65535	R/W
46	A L.HY	Alarm hysteresis value	*2	*2	R/W
47	A L.FT	Alarm failure transfer	0	65535	R/W
48	E IFN	Event input function	0	65535	R/W
49	D ISP	Normal display format	0	65535	R/W
50	A OHI	Analog output scale high	*1	*1	R/W
51	A D0	mV calibration low coefficient	-1999.9	4553.6	R/W
52	A DG	mV calibration high coefficient	-1999.9	4553.6	R/W
53	C JTL	Cold junction calibration low coefficient	-199.99	455.36	R/W
54	C JG	Cold junction calibration high coefficient	-1999.9	4553.6	R/W
55	R EF	RTD calibration low coefficient	-1999.9	4553.6	R/W
56	S R	RTD calibration high coefficient	-1999.9	4553.6	R/W
57		Reserved			
58	D ATE	Manufacturing date of the product	0	65535	R/W
59	N O	Serial number of the product	0	65535	R/W
60	H OUR	Working hours of the product	0	65535	R/W
61	H RLO	Fractional value of hour	0	65535	R/W

Register Address	Parameter Notation	Parameter	Scale Low	Scale High	Notes
128	PV	Process value	*1	*1	R
129	HSP1	High limit set point 1	*1	*1	R
130	LSP1	Low limit set point 1	*1	*1	R
131	T.ABN	Accumulated time during abnormal condition	0	6553.5	R
132	ALM	Output 1 status *4	0	65535	R
140	PROG	Program code *3	0.00	655.35	R
142	CMND	Command code	0	65535	R/W
143	JOB	Job code	0	65535	R/W

*1: The scale high/low values are defined in the following table for the parameters HSP1, LSP1, SP2, PV.HI, PV.LO, IN.LO, IN.HI, SHIF, HSP.L, HSP.H, LSP.L, LSP.H, PV, AOLO and AOHI:

Conditions	Non-linear input	Linear input RESO = 0	Linear input RESO = 1	Linear input RESO = 2	Linear input RESO = 3
Scale low	-1999.9	-19999	-1999.9	-199.99	-19.999
Scale high	4553.6	45536	4553.6	455.36	45.536

*2: The scale high/low values are defined in the following table for the parameters O1.HY and AL.HY :

Conditions	Non-linear input	Linear input RESO = 0	Linear input RESO = 1	Linear input RESO = 2	Linear input RESO = 3
Scale low	0.0	0	0.0	0.00	0.000
Scale high	6553.5	65535	6553.5	655.35	65.535

*3: The PROG code is defined by 2.XX, where XX denotes the software version number. For example : PROG=2.17 means the product is L91 with software version 17.

*4: The least significant bit (LSB) of ALM shows the status of output 1. LSB=1 if output 1 is ON (normal condition).

7-4 Data Conversion

The word data are regarded as unsigned (positive) data in the Modbus message. However, the actual value of the parameter may be negative value with decimal point. The high/low scale values for each parameter are used for the purpose of such conversion.

Let M = Value of Modbus message
A = Actual value of the parameter
SL = Scale low value of the parameter
SH = Scale high value of the parameter

The conversion formulas are as follows:

$$M = \frac{65535}{SH-SL} \cdot (A - SL)$$

$$A = \frac{SH-SL}{65535} \cdot M + SL$$

7-5 Communication Examples :

Example 1: Down load the default values via the programming port

The programming port can perform Modbus communications regardless of the incorrect setup values of address, baud, parity, stop bit etc. It is especially useful during the first time configuration for the controller. The host must be set with 9600 baud rate, 8 data bits, even parity and 1 stop bit.

The Modbus message frame with hexadecimal values is shown as follows:

(1) Unlock the controller

	06	00	8E	68	2C	HI	LO
Addr.	Func.	Reg. Addr.		CMND=26668		CRC16	

(2) Preset the first group of the parameters

	10	00	09	00	07	0E	00	01	00	00
Addr.	Func.	Starting Addr.	No. of words		Bytes	INPT=1		UNIT=0		

00	01	4E	1F	52	07	4E	1F	00	02	HI	LO
RESO=1		IN.LO=0		IN.HI=100.0		SHIF=0.0		FILT=2		CRC16	

(3) Preset the second group of the parameters

	10	00	01	00	03	06	52	07	4E	1F	51	A3	HI	LO
Addr.	Func.	Starting Addr.	No. of words		Bytes	HSP1=100.0		LSP1=0.0		SP2=90.0		CRC16		

(4) Preset the third group of the parameters

	10	00	11	00	13	26	00	02	00	00	00	00	00	01
Addr.	Func.	Starting Addr.	No. of words		Bytes	OUT1=2		Reserved		Reserved		O1.HY=0.1		

00	00	00	00	00	00	00	00	00	00	00	00	00	4E	1F	
Reserved		Reserved		Reserved		Reserved		Reserved		Reserved		Reserved		HSPL=0	

52	07	4A	37	4E	1F	00	00	00	00	00	00	00	04	HI	LO
HSPH=100.0		LSPL=-100.0		LSPH=0		Reserved		Reserved		Reserved		OUT2=4		CRC16	

(5) Preset the rest parameters

	10	00	28	00	0A	14	00	01	00	05	00	00	00	00
Addr.	Func.	Starting Addr.	No. of words		Bytes	ADDR=1		BAUD=5		PARI=0		Reserved		

00	06	00	00	00	01	00	01	00	00	00	00	HI	LO
AL.FN=6		AL.MD=0		AL.HY=0.1		AL.FT=1		EIFN=0		DISP=0		CRC16	

Example 2: Read the process value (PV)

Send the following message to the controller via the COMM port or the programming port :

Query

	03	00	80	00	01	HI	LO
Addr.	Func.	Starting Addr.		No. of words		CRC16	

Example 3: Perform reset function (same effect as pressing key):

Query

	06	00	8E	68	25	HI	LO
Addr.	Func.	Starting Addr.		CMND=26661		CRC16	

Example 4: Read 22 parameters at most one time

Query

	03			00	16	HI	LO
Addr.	Func.	Starting Addr.		No. of words		CRC16	

Table A.1 Error Codes and Corrective Actions

Error Code	Display Symbol	Error Description	Corrective Action
10	<i>Er 10</i>	Communication error: bad function code	Correct the communication software to meet the protocol requirements.
11	<i>Er 11</i>	Communication error: register address out of range	Don't issue an over-range register address to the slave.
14	<i>Er 14</i>	Communication error: attempt to write a read-only data or a protected data	Don't write a read-only data or a protected data to the slave.
15	<i>Er 15</i>	Communication error: write a value which is out of range to a register	Don't write an over-range data to the slave register.
39	<i>SEnb</i> <i>SbnE</i>	Input sensor break, or input current below 1 mA if 4-20 mA is selected, or input voltage below 0.25V if 1 - 5V is selected	Replace input sensor.
40	<i>RdEr</i>	A to D converter or related component(s) malfunction	Return to factory for repair.

FW Version 22 & later, the display will change to *SbnE*

WARRANTY

Brainchild Electronic Co., Ltd. is pleased to offer suggestions on the use of its various products. However, Brainchild makes no warranties or representations of any sort regarding the fitness for use, or the application of its products by the Purchaser. The selection, application or use of Brainchild products is the Purchaser's responsibility. No claims will be allowed for any damages or losses, whether direct, indirect, incidental, special or consequential. Specifications are subject to change without notice. In addition, Brainchild reserves the right to make changes-without notification to Purchaser-to materials or processing that do not affect compliance with any applicable specification. Brainchild products are warranted to be free from defects in material and workmanship for 18 months after delivery to the first purchaser for use. An extended period is available with extra cost upon request. Brainchild's sole responsibility under this warranty, at Brainchild's option, is limited to replacement or repair, free of charge, or refund of purchase price within the warranty period specified. This warranty does not apply to damage resulting from transportation, alteration, misuse or abuse.

RETURNS

No products return can be accepted without a completed Return Material Authorization (RMA) form.



- Please install 20A circuit breaker on the power supply end
 - To remove the dust please use the dry cloth
 - The installation that the safety of any system incorporating the equipment is the responsibility of the assembler of the system
 - If the equipment is used in a manner not specified by the manufacturer, the protection provided by the equipment may be impaired
 - Do not cover the cooling vents to maintain airflow
 - Beware not to over-tighten the terminal screws. The torque should not exceed 1.14 N-m (10 Lb-in or 11.52 Kgf-cm), temperature Min. 60°C, use copper conductors only.
-
- Veuillez installer un disjoncteur 20A à l'extrémité de l'alimentation
 - Pour enlever la poussière, veuillez utiliser le chiffon sec
 - L'installation que la sécurité de tout système incorporant l'équipement est la responsabilité de l'assembleur du système
 - Si l'équipement est utilisé d'une manière non spécifiée par le fabricant, la protection fournie par l'équipement peut être altérée
 - Ne couvrez pas les événements de refroidissement pour maintenir le flux d'air
 - Attention, veuillez ne pas trop serrer les vis des bornes. Le couple ne doit pas dépasser 1,14 N-m (10 Lb-in ou 11,52 Kgf-cm). La température minimale est de 60°C. Utilisez uniquement des conducteurs en cuivre.

For any repair or maintenance needs, please contact us.

BrainChild Electronic Co., Ltd.

No.209, Chung Yang Rd., Nan Kang Dist.,

Taipei 11573, Taiwan

Tel: 886-2-27861299

Fax: 886-2-27861395

web site: <http://www.brainchildtw.com>