

User's Manual



DIN EN ISO 9001
Certificate: 01 100 98505



P41 / P91
Auto-Tune Fuzzy / PID
Profiling Controller



BrainChild

UM0P4111

Warning Symbol

The Symbol calls attention to an operating procedure, practice, or the like, which, if not correctly performed or adhered to, could result in personal injury or damage to or destruction of part or all of the product and system. Do not proceed beyond a warning symbol until the indicated conditions are fully understood and met.

Use the Manual

- Installers Read Chapter 1, 2
- System Designer Read All Chapters
- Expert User Read Page 15,16

NOTE:

It is strongly recommended that a process should incorporate a LIMIT CONTROL like L91 which will shut down the equipment at a preset process condition in order to preclude possible damage to products or system.

Information in this user's manual is subject to change without notice.

This manual is applicable for the products with software version 22 and later version.

Copyright © 2023, The Brainchild Electronic Co., Ltd., all rights reserved. No part of this publication may be reproduced, transmitted, transcribed or stored in a retrieval system, or translated into any language in any form by any means without the written permission of the Brainchild Electronic Co., Ltd.

Contents

	Page No		Page No
Chapter 1 Overview		Chapter 4 Profiler Operation	
1-1 General -----	5	4-1 What is set point profiler ---	65
1-2 Ordering Code -----	9	4-2 Segment connection -----	66
1-3 Programming Port -----	11	4-3 Profiler Modes -----	66
1-4 Keys and Displays -----	12	4-4 Running, holding and aborting a profile -----	67
1-5 Key Operation Flowchart---	15	4-5 Viewing and modifying profile progress -----	68
1-6 Parameter Descriptions ----	17	4-6 Start -----	68
Chapter 2 Installation		4-7 Holdback -----	68
2-1 Unpacking -----	32	4-8 Power failure -----	71
2-2 Mounting -----	32	4-9 Configuring the profiler ---	73
2-3 Wiring precautions -----	34	4-10 Viewing and creating a profile -----	73
2-4 Power Wiring -----	36	4-11 Event Outputs and PID Selection -----	77
2-5 Sensor Input Wiring -----	36		
2-6 Control Output Wiring ----	36	Chapter 5 Applications -----	78
2-7 Alarm /Event Output Wiring -----	40	Chapter 6 Specifications ----	80
2-8 Event Input Wiring -----	41	Chapter 7	
2-9 Retransmission Output Wiring -----	41	Modbus Communications ---	86
2-10 Data Communication ----	42	7-1 Functions Supported -----	86
Chapter 3 Configuration		7-2 Exception Responses -----	88
3-1 Password-----	44	7-3 Parameter Table -----	88
3-2 Signal Input -----	44	7-4 Number System -----	89
3-3 Event Input -----	45	7-5 Communication Example --	89
3-4 Control Outputs -----	46	Chapter 8	
3-5 Alarms -----	51	Manual Calibration -----	95
3-6 Configure Home Page ----	55	Appendix A-1 -----	97
3-7 User Calibration -----	55	Appendix A-2 -----	98
3-8 Digital Filter -----	57		
3-9 Failure Transfer -----	58		
3-10 Auto-tuning -----	59		
3-11 Manual tuning -----	60		
3-12 Manual Mode -----	62		
3-13 Data Communication ----	62		
3-14 Retransmission -----	63		
3-15 Output Scaling -----	64		

Figure 1.1 Fuzzy Control Advantage	6
Figure 1.2 Programming Port Overview	11
Figure 1.3 Front Panel Description	13
Figure 1.4 Program code display	14
Figure 2.1 Mounting Dimensions	33
Figure 2.2 Lead Termination for P41	34
Figure 2.3 Lead Termination for P91	34
Figure 2.4 Rear Terminal Connection for P41	35
Figure 2.5 Rear Terminal Connection for P91	35
Figure 2.6 Power Supply Connections	36
Figure 2.7 Sensor Input Wiring	36
Figure 2.8 Output 1 Relay or Triac (SSR) to Drive Load	36
Figure 2.9 Output 1 Relay or Triac (SSR) to Drive Contactor	37
Figure 2.10 Output 1 Pulsed Voltage to Drive SSR	37
Figure 2.11 Output 1 Linear Current	38
Figure 2.12 Output 1 Linear Voltage	38
Figure 2.13 Output 2 Relay or Triac (SSR) to Drive Load	38
Figure 2.14 Output 2 Relay or Triac (SSR) to Drive Contactor	39
Figure 2.15 Output 2 Pulsed Voltage to Drive SSR	39
Figure 2.16 Output 2 Linear Current	39
Figure 2.17 Output 2 Linear Voltage	40
Figure 2.18 Alarm / Event output wiring	40
Figure 2.19 Alarm Output to Drive Contactor	40
Figure 2.20 Event Input wiring	41
Figure 2.21 Retransmit 4-20 / 0-20 mA Wiring	41
Figure 2.22 RS-485 Wiring	42
Figure 2.23 RS-232 Wiring	43
Figure 2.24 Configuration of RS-232 Cable	43
Figure 3.1 Conversion Curve for Linear Type Process Value	45
Figure 3.2 Heat Only ON-OFF Control	47
Figure 3.3 Heat - cool Control	49
Figure 3.4 Process high alarm 1 operation	51
Figure 3.5 Process low alarm 1 operation	51
Figure 3.6 Deviation high alarm 1 operation	52
Figure 3.7 Deviation low alarm 1 operation	52
Figure 3.8 Deviation band alarm 1 operation	53
Figure 3.9 Two point user calibration	56
Figure 3.10 Filter Characteristics	57
Figure 3.11 Effects of PID Adjustment	61
Figure 3.12 Output scaling function	64
Figure 4.1 Set point profile	65
Figure 4.2 Holdback operation	70
Figure 4.3 Recovery from profile at dwell segment	71
Figure 4.4 Recovery from profile at ramp segment	71
Figure 4.5 Recovery from PV at dwell segment	72
Figure 4.6 Recovery from PV at ramp segment	72
Figure 4.7 Profiling curve example	75
Figure 5.1 A Heat Treatment Oven	78
Figure 5.2 Temperature profile of the Heat Treatment Oven	79
Table 3.1 Password operation	44
Table 3.2 Heat-Cool control configuration value	46
Table 3.3 Alarm mode description	54
Table 3.4 PID Adjustment Guide	60
Table 4.1 Segment types	65
Table 4.2 Profiler Modes	67
Table 4.3 Parameters that follow segment type	74
Table 7.1 Exception Code Table	88
Table 7.2 Number Conversion Table	89
Table A.1 Error Codes and Corrective Actions	95

Chapter 1 Overview

1-1 General

The Fuzzy Logic plus PID microprocessor-based profiling controller series, incorporate two bright, easy to read 4-digit LED displays, indicating process value and set point value. The Fuzzy Logic technology enables a process to reach a predetermined set point in the shortest time, with the minimum of overshoot during power-up or external load disturbance.

P91 is a 1/16 DIN size panel mount profiling controller. It can also be used for rail mount by adding a rail mount kit. P41 is a 1/4 DIN size panel mount profiling controller. These units are powered by 11-26 or 90-250 VDC/VAC supply, incorporating a 2 amp. control relay output as standard. The second output can be used as cooling control, an event output or an alarm. Both outputs can select triac, logic output, linear current or linear voltage to drive external device. The units are fully programmable for PT100 and thermocouple types J, K, T, E, B, R, S, N, L, C, P with no need to modify the unit. The input signal is digitized by using a 18-bit A to D converter. Its fast sampling rate allows the unit to control fast processes.

There are more functions than the heating and cooling control could be configured for the controller outputs, these include: up to three alarm outputs, up to three event outputs and up to two analog retransmission outputs.

Digital communications RS-485 or RS-232 are available as an additional option. These options allow the units to be integrated with supervisory control system and software.

A programming port is available for automatic configuration, calibration and testing without the need to access the keys on front panel.

By using proprietary Fuzzy modified PID technology, the control loop will minimize the overshoot and undershoot in a shortest time. The following diagram is a comparison of results with and without Fuzzy technology.

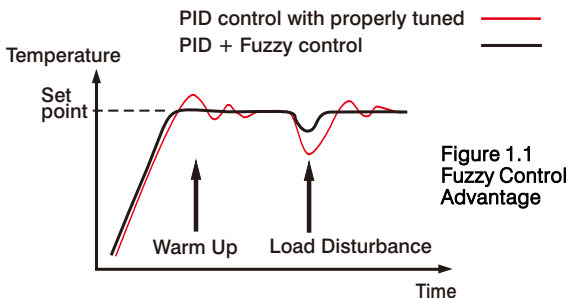

The series can be configured as a single set point controller (static mode) or a ramp and dwell profiling controller (profile mode). The profile mode feature allows the user to program up to 9 profiles of up to 64 free-format (ramp, dwell, jump or end) segments each. The total segments available for the product is 288 segments. The profiling controllers contain the following features:

Flexible Configuration of Program

There are up to 64 segments can be defined for a profile. Each segment can be configured as a ramp or a dwell (soak) segment or defining a repeat number of cycles at arbitrary location within the profile and finally terminated by an end segment. The user can edit a currently running profile.

Maximum Capacity of Program

There are at most 9 profiles can be defined and 288 segments totally available for all profiles. The profiles are divide into three kinds of length. The short length profile contains 16 segments, the medium length profile contains 32 segments while the long length profile contains 64 segments at most.

Event Input

The event input feature allows the user to select one of eight functions: enter profile run mode, enter profile hold mode, abort profile mode, enter manual mode, perform failure transfer, enter off mode, advance to the next segment and select second set of PID values.

Programmable Event Outputs

Up to three relays are configurable for event outputs and the state of each output can be defined for each segment and end of profile.

Analog Retransmission

The output 5 and output 4 (P41 only) of the products can be equipped with analog output module. The output can be configured for transmitting the process value as well as set point value.

High Accuracy

The series are manufactured with custom designed ASIC(Application Specific Integrated Circuit) technology which contains a 18-bit A to D converter for high resolution measurement (true 0.1 °F resolution for thermocouple and PT100) and a 15-bit D to A converter for linear current or voltage control output. The ASIC technology provides improved operating performance, low cost, enhanced reliability and higher density.

Fast Sampling Rate

The sampling rate of the input A to D converter reaches 5 times/second. The fast sampling rate allows this series to control fast processes.

Fuzzy Control

The function of Fuzzy control is to adjust PID parameters from time to time in order to make manipulation output value more flexible and adaptive to various processes. The results is to enable a process to reach a predetermined set point in the shortest time, with the minimum of overshoot and undershoot during power-up or external load disturbance.

Digital Communication

The units are equipped with RS-485 or RS-232 interface card to provide digital communication. By using the twisted pair wires there are at most 247 units can be connected together via RS-485 interface to a host computer.

Programming Port

A programming port is used to connect the unit to a hand-held programmer or a PC for quick configuration, also can be connected to an ATE system for automatic testing & calibration.

Auto-tune

The auto-tune function allows the user to simplify initial setup for a new system. A clever algorithm is provided to obtain an optimal set of control parameters for the process, and it can be applied either as the process is warming up (cold start) or as the process has been in steady state (warm start).

Lockout Protection

According to actual security requirement, a password is provided to prevent the unit from being changed abnormally.

Bumpless Transfer

Bumpless transfer allows the controller to continue to control by using its previous value as the sensor breaks. Hence, the process can be well controlled temporarily as if the sensor is normal.

Digital Filter

A first order low pass filter with a programmable time constant is used to improve the stability of process value. This is particularly useful in certain application where the process value is too unstable to be read.

SEL Function

The units have the flexibility for user to select those parameters which are most significant to him and put these parameters in the home page. There are at most 8 parameters can be selected to allow the user to build his own display sequence.

1-2 Ordering Code

P41-
P91-

Power Input

- 4: 90 - 250 VAC, 47-63 Hz
- 5: 11 - 26 VAC or VDC, SELV, Limited Energy

Signal Input

- 1: Standard Input
- Thermocouple:
 - J, K, T, E, B, R, S, N, L, C, P
- RTD: PT100 DIN, PT100 JIS
- Voltage: 0-60mV
- 5: 0-10V, 0-1V, 0-5V, 1-5V
- 6: 0-20/4-20 mA

Output 1

- 0: None
- 1: Relay rated 2A/240VAC
- 2: Pulsed voltage to drive SSR, 5V/30mA
- 3: Isolated 4 - 20mA / 0 - 20mA
- 4: Isolated 1 - 5V / 0 - 5V/0 - 10V
- 6: Triac output 1A / 240VAC, SSR
- C: Pulsed voltage to drive SSR, 14V/40mA

Output 2

- 0: None
- 1: Relay rated 2A/240VAC
- 2: Pulsed voltage to drive SSR, 5V/30mA
- 3: Isolated 4 - 20mA / 0 - 20mA
- 4: Isolated 1 - 5V / 0 - 5V/0 - 10V
- 6: Triac output 1A / 240VAC, SSR
- 7: Isolated 20V/25mA transducer power supply
- 8: Isolated 12V/40mA transducer power supply
- A: Isolated 5V/80mA transducer power supply
- C: Pulsed voltage to drive SSR, 14V/40mA

Standard leave blank
Special Order AA-ZZ

Options

- 0: Panel mount IP50 standard
- 1: Panel mount IP65 water resistant rubber installed
- 2: DIN rail mount with IP50 (for P91 only)
- 3: DIN rail mount with IP65 (for P91 only)

Output 5

- 0: None
- 3: Retransmit 4 - 20mA / 0 - 20mA
- 4: Retransmit 1 - 5V / 0 - 5V/0 - 10V
- 7: Isolated 20V/25mA transducer power supply
- 8: Isolated 12V/40mA transducer power supply
- A: Isolated 5V/80mA transducer power supply
- D: Isolated RS-485 interface
- E: Isolated RS-232 interface

Output 4

- 0: None
- 1: Relay rated 2A/240VAC
- 2: Pulsed voltage to drive SSR, 5V/30mA
- 3: Retransmit 4 - 20mA / 0 - 20mA
- 4: Retransmit 1 - 5V / 0 - 5V/0 - 10V
- 6: Triac output 1A / 240VAC, SSR
- 7: Isolated 20V/25mA transducer power supply
- 8: Isolated 12V/40mA transducer power supply
- A: Isolated 5V/80mA transducer power supply
- C: Pulsed voltage to drive SSR, 14V/40mA

Output 3

- 0: None
- 1: Relay rated 2A/240VAC
- 2: Pulsed voltage to drive SSR, 5V/30mA
- 6: Triac output 1A / 240VAC, SSR
- 7: Isolated 20V/25mA transducer power supply
- 8: Isolated 12V/40mA transducer power supply
- A: Isolated 5V/80mA transducer power supply
- C: Pulsed voltage to drive SSR, 14V/40mA

Accessories

- OM94-6 = Isolated 1A / 240VAC Triac Output Module (SSR)
- OM94-7 = 14V / 40mA SSR Drive Module
- OM98-3 = Isolated 4 - 20 mA / 0 - 20 mA Analog Output Module
- OM98-5 = Isolated 0 -10V Analog Output Module
- CM94-1 = Isolated RS-485 Interface Module for P41 Output 5
- CM94-2 = Isolated RS-232 Interface Module for P41 Output 5
- CM94-3 = Isolated 4-20mA/0-20mA Retrains Module for P41 Output 5
- CM94-5 = Isolated 0-10V Retrains Module for P41 Output 5
- CM97-1 = Isolated RS-485 Interface Module for P91 Output 5
- CM97-2 = Isolated RS-232 Interface Module for P91 Output 5
- CM97-3 = Isolated 4-20mA/0-20mA Retrains Module for P91 Output 5
- CM97-5 = Isolated 0-10V Retrains Module for P91 Output 5
- DC94-1 = Isolated 20V/25mA DC Output Power Supply
- DC94-2 = Isolated 12V/40mA DC Output Power Supply
- DC94-3 = Isolated 5V/80mA DC Output Power Supply
- DC97-1 = Isolated 20V/25mA DC Output Power Supply for P91 Output 5
- DC97-2 = Isolated 12V/40mA DC Output Power Supply for P91 Output 5
- DC97-3 = Isolated 5V/80mA DC Output Power Supply for P91 Output 5
- CC94-1 = RS-232 Interface Cable (2M)
- CC91-1 = Programming Port Cable
- RK91-1 = Rail Mount kit for BTC-9100 / P91
- DC21-1 = Isolated 20V/25mA DC Output Power Supply for P41 Output 5
- DC21-2 = Isolated 12V/40mA DC Output Power Supply for P41 Output 5
- DC21-3 = Isolated 5V/80mA DC Output Power Supply for P41 Output 5

Related Products

- SNA12A = Smart Network Adapter for programming port to RS-232 interface
- BC-Set Pro = Configuration Software

1-3 Programming Port

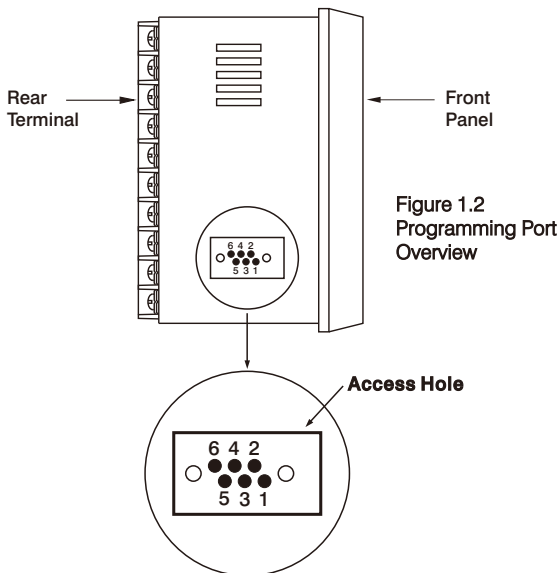

A special connector can be used to touch the programming port which is connected to a PC for automatic configuration, also can be connected to an ATE system for automatic calibration and testing.

The programming port is used for off-line automatic setup and testing procedures only. Don't attempt to make any connection to these pins when the unit is used for a normal control purpose.

1- 4 Keys and Displays

KEYPAD OPERATION

SCROLL KEY : 

This key is used to select a parameter to be viewed or adjusted.

UP KEY : 

This key is used to increase the value of selected parameter.

DOWN KEY : 

This key is used to decrease the value of selected parameter.

PAGE KEY: 

This key is used to select desired page of parameters.

REVERSE SCROLL :  

Press both  and  keys to jump to the previous parameter.

RESET KEY :  

Press both  and  keys to :

1. Revert the display to display the process value.
2. Reset the latching alarm, once the alarm condition is removed.
3. Stop the manual control mode , auto-tuning mode and off mode, then enters the static mode.
4. Clear the message of communication error, holdback time out error and auto-tuning error.
5. To reset new profile start segment to 1.00 after earlier profile is completed when " RUN" and "HLD" LED's are blinking together.

ENTER KEY : Press  for 5 seconds to :

1. Enter the selected mode to run.
2. Execute calibration procedure for the low point and high point calibration.

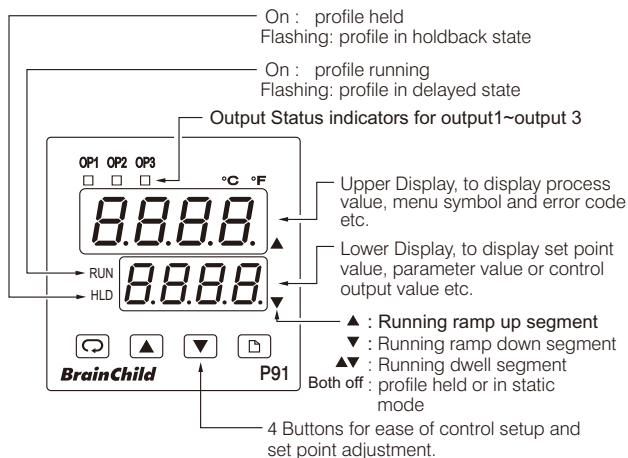
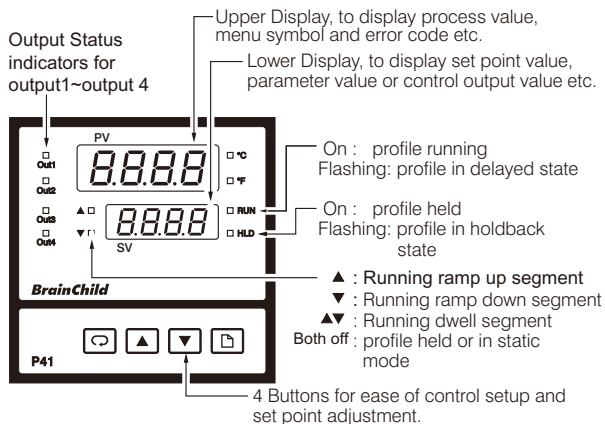
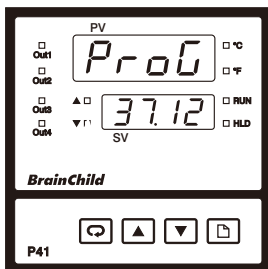

Figure 1.3 Front Panel Description



The unit will display the program code for 2.5 seconds during power up. The display shows program number 37 with program version 12. The program no. for P41 is 37 and for P91 is 38.

Figure 1.4 Program code display

1-5 Key Operation Flowchart

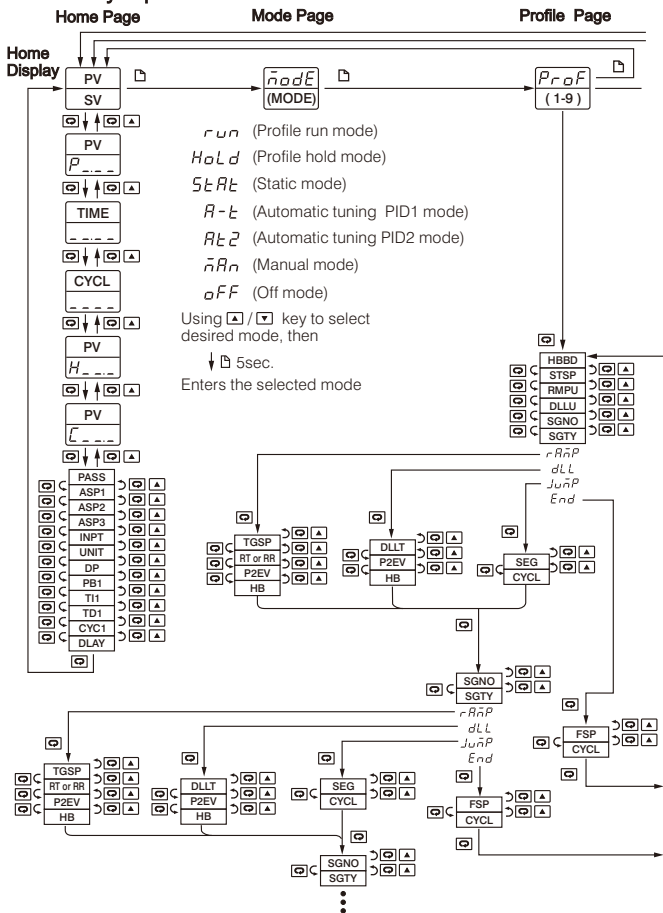

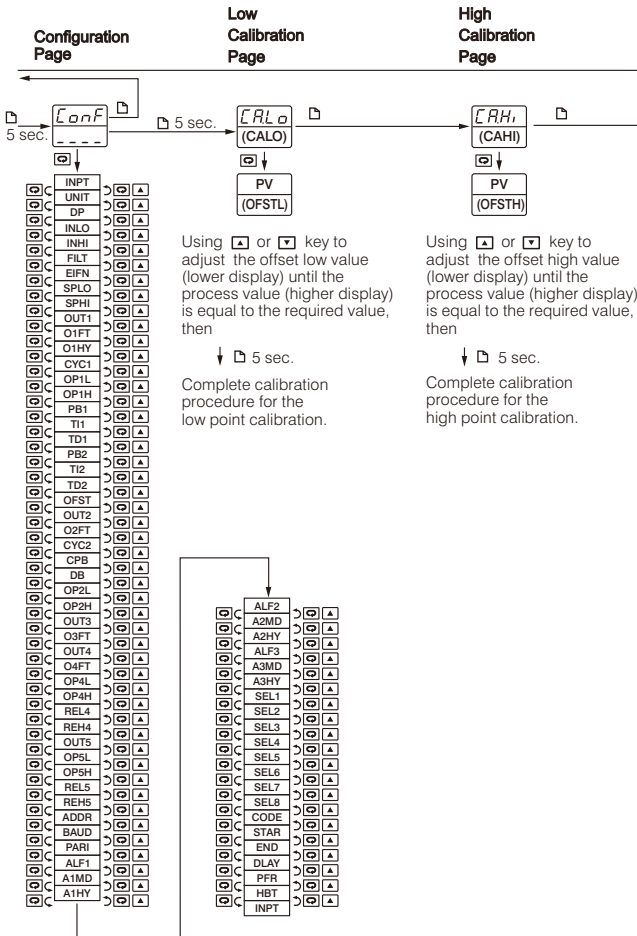

1-6 Parameter Descriptions

Register Address	Parameter Notation	Parameter Description	Range	Default Value	Data type
0	SP1	Controller (Static mode) Set point value	Low: SPLO High: SPHI	25.0 °C (77.0 °F)	R/W
1	PFSG P _ _ _	Indicate the current Profile/Segment number	Low: 1.00 High: 9.63 Profile number ———— Segment number ————	1.00	R/W
2	TIME t, nE	Time remaining for the current segment	Low: 00.00 High: 99.59	—	R/W
3	CYCL CYCL	cycle remaining for the current profile	Low: 1 High: 9999 10000=infinite	—	R
4	PASS PASS	Password entry	Low: 0 High: 9999	1	R/W
5	ASP1 ASP1	Set point for alarm 1	Low: -32768 High: 32767	10.0 °C (18.0 °F)	R/W
6	ASP2 ASP2	Set point for alarm 2	Low: -32768 High: 32767	10.0 °C (18.0 °F)	R/W
7	ASP3 ASP3	Set point for alarm 3	Low: -32768 High: 32767	10.0 °C (18.0 °F)	R/W
8	INPT i, nPt	Input sensor selection	(T/C=thermocouple) 0 J _ tC : J type T/C 1 K _ tC : K type T/C 2 t _ tC : T type T/C 3 E _ tC : E type T/C 4 b _ tC : B type T/C 5 r _ tC : R type T/C 6 S _ tC : S type T/C 7 n _ tC : N type T/C 8 L _ tC : L type T/C 9 C _ tC : C type T/C 10 P _ tC : P type T/C 11 Pt.dn : PT 100 ohms DIN curve 12 Pt.JS : PT 100 ohms JIS curve	1 (0)	R/W

Register Address	Parameter Notation	Parameter Description	Range	Default Value	Data type
8	INPT INPT	Input sensor selection	13 4-20 : 4 - 20 mA linear current input 14 0-20 : 0 - 20 mA linear current input 15 0-60 : 0 - 60 mV linear millivolt input 16 0-1V : 0 - 1V linear voltage input 17 0-5V : 0 - 5V linear voltage input 18 1-5V : 1 - 5V linear voltage input 19 0-10 : 0 - 10V linear voltage input	1 (0)	R/W
9	UNIT UNIT	Input unit selection	0 °C : Degree C unit 1 °F : Degree F unit 2 Pu : Process unit	0 (1)	R/W
10	DP dP	Decimal point selection	0 nodP : No decimal point 1 1-dP : 1 decimal digit 2 2-dP : 2 decimal digits 3 3-dP : 3 decimal digits	1	R/W
11	MODE modE	Operation mode	0 run :Profile run mode 1 HoLd :Profile hold mode 2 StARt :Static mode 3 A-t :Automatic tuning PID1 mode 4 At2 : Automatic tuning PID2 mode 5 MAN :Manual mode 6 oFF :Off mode	0	R/W
12	INLO INLO	Input low scale value	Low: -32768 High: INHI-50	-17.8 °C (0 °F)	R/W
13	INHI INHI	Input high scale value	Low: INLO+50 High: 32767	93.3 °C (200.0 °F)	R/W

Register Address	Parameter Notation	Parameter Description	Range	Default Value	Data type
14	FILT F, Lt	Filter damping time constant of PV	0 0 : 0 second time constant 1 0.2 : 0.2 second time constant 2 0.5 : 0.5 second time constant 3 1 : 1 second time constant 4 2 : 2 seconds time constant 5 5 : 5 seconds time constant 6 10 : 10 seconds time constant 7 20 : 20 seconds time constant 8 30 : 30 seconds time constant 9 60 : 60 seconds time constant	2	R/W
15	EIFN E, Fn	Event input function	0 nonE : No function 1 run : Program run mode 2 Hold : Program hold mode 3 Abort : Abort profile mode 4 nAn : Manual mode 5 FErrA : Failure Transfer 6 OFF : Off mode 7 PASS : Pass to the next segment 8 P, d2 : Select PB2 T12 & TD2 for control	0	R/W
16	SPLO SPLO	Low limit of set point value	Low: -32768 High: SPHI	-17.8 °C (0 °F)	R/W
17	SPHI SPHI	High limit of set point value	Low: SPLO High: 32767	537.8 °C (1000 °F)	R/W
18	OUT1 out 1	Output 1 function	0 nonE : No function 1 HOnF : Heating on-off control 2 HtPC : Heating time proportioning control 3 HLn : Heating linear control 4 COnF : Cooling on-off control 5 CtPC : Cooling time proportioning control 6 CLn : Cooling linear control	3	R/W

Register Address	Parameter Notation	Parameter Description	Range	Default Value	Data type
19	O1FT o1Ft	Output 1 failure transfer status	Select BPLS (bumpless transfer) or 0.0 ~ 100.0 % to continue output 1 control function as the unit fails, or select OFF (0) or ON (1) for ON-OFF control.	0	R/W
20	O1HY o1HY	Output 1 ON-OFF control hysteresis	Low: 0.1 High:50.0 °C(90.0°F)	0.1°C (0.2 °F)	R/W
21	CYC1 CYC1	Output 1 cycle time	Low: 0.1 High: 90.0 sec.	18.0	R/W
22	OP1L oP1L	Low limit value for output 1	Low: 0 High: 100.0 %	0	R/W
23	OP1H oP1H	High limit value for output 1	Low: 0 High: 120.0 %	100.0	R/W
24	PB1 Pb1	Proportional band value 1	Low: 0 High: 500.0 °C (900.0 °F)	10.0 °C (18.0 °F)	R/W
25	TI1 t11	Integral time value 1	Low: 0 High: 3600 sec	100	R/W
26	TD1 td1	Derivative time value 1	Low: 0 High: 900.0 sec	25.0	R/W
27	PB2 Pb2	Proportional band value 2	Low: 0 High: 500.0 °C (900.0 °F)	10.0 °C (18.0 °F)	R/W
28	TI2 t12	Integral time value 2	Low: 0 High: 3600 sec	100	R/W
29	TD2 td2	Derivative time value 2	Low: 0 High: 900.0 sec	25.0	R/W
30	OFST oFSt	Offset value for P control (TI=0)	Low : 0.0 High : 100.0%	25.0	R/W
31		Reserved			
32		Reserved			
33	OUT2 out2	Output 2 function	0 nonE: No function 1 CtPC: Cooling time proportioning control 2 CLn: Cooling linear control 3 ALn1: Alarm 1 output 4 rAL1: Reverse alarm 1 Output 5 EYn1: Event 1 output 6 dCPS: DC power supply output	3	R/W

Register Address	Parameter Notation	Parameter Description	Range	Default Value	Data type
34	O2FT o2Ft	Output 2 failure transfer status	Select BPLS (bumpless transfer) or 0.0 ~ 100.0 % to continue output 2 control function as the unit fails, or select OFF (0) or ON (1) for alarm or event output.	0	R/W
35	CYC2 CYC2	Output 2 cycle time	Low: 0.1 High: 90.0 sec.	18.0	R/W
36	CPB CPb	Cooling proportional band value	Low: 50 High: 300 %	100	R/W
37	DB db	Heating-cooling dead band (negative value= overlap)	Low: -36.0 High: 36.0 %	0	R/W
38	OP2L oP2L	Low limit value for output 2	Low: 0 High: 100.0 %	0	R/W
39	OP2H oP2H	High limit value for output 2	Low: 0 High: 120.0 %	100.0	R/W
40		Reserved			
41		Reserved			
42	OUT3 out3	Output 3 function	0 none : No function 1 AL2 : Alarm 2 output 2 rAL2 : Reverse alarm 2 output 3 E2 : Event 2 output 4 dCPS : DC power supply output	3	R/W
43	O3FT o3Ft	Output 3 failure transfer status	0 OFF : Output 3 OFF as unit fails 1 ON : Output 3 ON as unit fails	0	R/W
44	OUT4 out4	Output 4 function (for P41 only)	0 none : No function 1 AL3 : Alarm 3 output 2 rAL3 : Reverse alarm 3 output 3 E3 : Event 3 output 4 rEPV : Retransmit process value 5 rESP : Retransmit set point value 6 dCPS : DC power supply output	3	R/W

Register Address	Parameter Notation	Parameter Description	Range	Default Value	Data type
45	O4FT o4Ft	Output 4 failure transfer status (for P41 only)	0 <i>oFF</i> : Output 4 OFF as unit fails 1 <i>oN</i> : Output 4 ON as unit fails	0	R/W
46	OP4L oP4L	Low limit value for output 4 (for P41 only)	Low: 0 High: 100.0 %	0	R/W
47	OP4H oP4H	High limit value for output 4 (for P41 only)	Low: 0 High: 120.0 %	100.0	R/W
48	REL4 rEL4	Retransmission low scale value for output4 (for P41 only)	Low: -32768 High:32767	0.0 °C (32.0°F)	R/W
49	REH4 rEH4	Retransmission high scale value for output4 (for P41 only)	Low: -32768 High:32767	10 0.0 °C (212.0°F)	R/W
50		Reserved			
51	OUT5 oUt5	Output 5 function	0 <i>nOnE</i> : No function 1 <i>CoMm</i> : Communication port 2 <i>rEPr</i> : Retransmit process value 3 <i>rESp</i> : Retransmit set point value 4 <i>dCPS</i> : DC power supply output	0	R/W
52	OP5L oP5L	Low limit value for output 5	Low: 0 High: 100.0 %	0	R/W
53	OP5H oP5H	High limit value for output 5	Low: 0 High: 120.0 %	100.0	R/W
54	REL5 rEL5	Retransmission low scale value for output 5	Low: -32768 High:32767	0.0 °C (32.0°F)	R/W
55	REH5 rEH5	Retransmission high scale value for output 5	Low: -32768 High:32767	10 0.0 °C (212.0°F)	R/W
56	ADDR Addr	Address assignment of digital communication	Low: 1 High: 247	1	R/W

Register Address	Parameter Notation	Parameter Description	Range	Default Value	Data type
57	BAUD <i>bRud</i>	Baud rate of digital communication	0 24 : 2.4 Kbits/s baud rate 1 48 : 4.8 Kbits/s baud rate 2 96 : 9.6 Kbits/s baud rate 3 144 : 14.4 Kbits/s baud rate 4 192 : 19.2 Kbits/s baud rate 5 288 : 28.8 Kbits/s baud rate 6 384 : 38.4 Kbits/s baud rate	2	R/W
58	PARI <i>PARr</i>	Parity bit of digital communication	0 <i>Even</i> : Even parity 1 <i>odd</i> : Odd parity 2 <i>nonE</i> : No parity bit	0	R/W
59	ALF1 <i>ALF1</i>	Alarm 1 function	0 <i>PYHi</i> : Process high alarm 1 <i>PYLo</i> : Process low alarm 2 <i>dEHi</i> : Deviation high alarm 3 <i>dELo</i> : Deviation low alarm 4 <i>dbHL</i> : Deviation band high/low alarm 5 <i>EndP</i> : End of profile alarm 6 <i>Hold</i> : Hold mode alarm 7 <i>StAt</i> : Static mode alarm	2	R/W
60	A1MD <i>A1nD</i>	Alarm 1 operation mode	0 <i>norā</i> : Normal alarm action 1 <i>latch</i> : Latching alarm action 2 <i>Hold</i> : Hold alarm action 3 <i>ltho</i> : Latching & hold alarm action	0	R/W
61	A1HY <i>A1HY</i>	Hysteresis control for alarm 1	Low: 0.1 High: 50.0 °C (90.0 °F)	0.1 °C (0.2 °F)	R/W

Register Address	Parameter Notation	Parameter Description	Range	Default Value	Data type
62	ALF2 ALF2	Alarm 2 function	0 <i>P_{UH}</i> : Process high alarm 1 <i>P_{UL}</i> : Process low alarm 2 <i>dEH</i> : Deviation high alarm 3 <i>dEL</i> : Deviation low alarm 4 <i>dbHL</i> : Deviation band high/low alarm 5 <i>EndP</i> : End of profile alarm 6 <i>Hold</i> : Hold mode alarm 7 <i>StAl</i> : Static mode alarm	2	R/W
63	A2MD A2nd	Alarm 2 operation mode	0 <i>nor</i> : Normal alarm action 1 <i>Lch</i> : Latching alarm action 2 <i>Hold</i> : Hold alarm action 3 <i>LtHo</i> : Latching & hold alarm action	0	R/W
64	A2HY A2HY	Hysteresis control for alarm 2	Low: 0.1 High: 50.0 °C (90.0 °F)	0.1 °C (0.2 °F)	R/W
65		Reserved			
66	ALF3 ALF3	Alarm 3 function (for P41 only)	0 <i>P_{UH}</i> : Process high alarm 1 <i>P_{UL}</i> : Process low alarm 2 <i>dEH</i> : Deviation high alarm 3 <i>dEL</i> : Deviation low alarm 4 <i>dbHL</i> : Deviation band high/low alarm 5 <i>EndP</i> : End of profile alarm 6 <i>Hold</i> : Hold mode alarm 7 <i>StAl</i> : Static mode alarm	2	R/W
67	A3MD A3nd	Alarm 3 operation mode (for P41 only)	0 <i>nor</i> : Normal alarm action 1 <i>Lch</i> : Latching alarm action 2 <i>Hold</i> : Hold alarm action 3 <i>LtHo</i> : Latching & hold alarm action	0	R/W

Register Address	Parameter Notation	Parameter Description	Range	Default Value	Data type
68	A3HY <i>A3HY</i>	Hysteresis control for alarm 3 (for P41 only)	Low: 0.1 High: 50.0 °C (90.0 °F)	0.1 °C (0.2 °F)	R/W
69		Reserved			
70	SEL1 <i>SEL1</i>	Select 1'st parameter for home page	0 <i>none</i> : No parameter selected 1 <i>INPT</i> : INPT selected for home page 2 <i>UNIT</i> : UNIT selected for home page 3 <i>DP</i> : DP selected for home page 4 <i>Pb1</i> : PB1 selected for home page 5 <i>t11</i> : T11 selected for home page 6 <i>td1</i> : TD1 selected for home page 7 <i>Pb2</i> : PB2 selected for home page 8 <i>t12</i> : T12 selected for home page 9 <i>td2</i> : TD2 selected for home page 10 <i>OFST</i> : OFST selected for home page 11 <i>O1HY</i> : O1HY selected for home page 12 <i>CYC1</i> : CYC1 selected for home page 13 <i>CYC2</i> : CYC2 selected for home page 14 <i>CPb</i> : CPB selected for home page 15 <i>db</i> : DB selected for home page 16 <i>A1HY</i> : A1HY selected for home page 17 <i>A2HY</i> : A2HY selected for home page 18 <i>A3HY</i> : A3HY selected for home page 19 <i>DLAY</i> : DLAY Selected for home page 20 <i>MANE</i> : Manual event output	0	R/W
71	SEL2 <i>SEL2</i>	Select 2'nd parameter for home page	Same as SEL1	0	R/W
72	SEL3 <i>SEL3</i>	Select 3'rd parameter for home page	Same as SEL1	0	R/W

Register Address	Parameter Notation	Parameter Description	Range	Default Value	Data type
73	SEL4 <i>SEL 4</i>	Select 4th parameter for home page	Same as SEL1	0	R/W
74	SEL5 <i>SEL 5</i>	Select 5th parameter for home page	Same as SEL1	0	R/W
75	SEL6 <i>SEL 6</i>	Select 6th parameter for home page	Same as SEL1	0	R/W
76	SEL7 <i>SEL 7</i>	Select 7th parameter for home page	Same as SEL1	0	R/W
77	SEL8 <i>SEL 8</i>	Select 8th parameter for home page	Same as SEL1	0	R/W
78	CODE <i>Code</i>	Security code for parameter protection	Low: 0 High: 9999 0=unprotected 1000= home page unprotected	0	R/W
79		Reserved			
80	STAR <i>Star</i>	Set point value at start of each profile	0 <i>PV</i> : Current process value PV 1 <i>SP 1</i> : Controller set point value SP1 2 <i>StSP</i> : Start set point value STSP	0	R/W
81	END <i>End</i>	Set point value at end of each profile	0 <i>FSP</i> : Final set point value for each program 1 <i>SP 1</i> : Controller set point value 2 <i>OFF</i> : All outputs go to off except end of profile relay	0	R/W
82	DLAY <i>dLAY</i>	Delay time (hours /minutes) between profile initiation and profile start	Low : 0.00 High : 99.59	0	R/W

Register Address	Parameter Notation	Parameter Description	Range	Default Value	Data type
83	PFR <i>P.F.r</i>	Power fail recovery	0 <i>cont</i> : Continue profile from the last set point value 1 <i>PU</i> : Start to run from PV 2 <i>SP1</i> : Static mode, SP1 3 <i>OFF</i> : OFF mode	2	R/W
84	HBT <i>Hbt</i>	Holdback wait time	Low : 0.00 High : 99.59 (hour.minute) 0.00 = <i>INF</i> : infinite	1.00	R/W
85		Reserved			
86	PROF <i>PrOF</i>	Profile number selected for view	Low: 1 High: 9	1	R/W
87	HBBB <i>Hbbd</i>	Holdback band	Low: 1 High: 555 °C (999°F)	—	R/W
88	STSP <i>St.SP</i>	Start set point value	Low : SPLO High : SPHI	—	R/W
89	RMPU <i>rñP.u</i>	Unit for ramp segment	0 <i>HHññ</i> : Hours. Minutes 1 <i>ññSS</i> : Minutes. Seconds 2 <i>lñ, ñ</i> : units per minute 3 <i>lHr</i> : units per hour	—	R/W
90	DLU <i>dLL.u</i>	Unit for dwell segment	0 <i>HHññ</i> : Hours. Minutes 1 <i>ññSS</i> : Minutes. Seconds	—	R/W
91	SGNO <i>SG.no</i>	Segment number	Low : 0 High: 15 (PROF=1~4) 31 (PROF=5~7) 63 (PROF=8,9)	—	R/W
92	SGTY <i>SG.ty</i>	Segment type for the selected segment number	0 <i>rññP</i> : Ramp 1 <i>dLL</i> : Dwell 2 <i>JññP</i> : Jump 3 <i>End</i> : End	3	R/W
93	TGSP <i>tG.SP</i>	Target set point for ramp segment	Low : SPLO High : SPHI	—	R/W

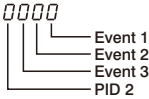
Register Address	Parameter Notation	Parameter Description	Range	Default Value	Data type
94	RTRR <i>r t r r</i>	Time duration or Ramp rate for ramp segment	Low: 0 High: 5999	—	R/W
95	P2EV <i>P 2 E V</i>	States assignment of PID selection and event outputs for ramp, and dwell segment.	Four-bit binary number (0=inactive 1=active) 	—	R/W
96	HBTY <i>H b t y</i>	Holdback type	0. <i>o F F</i> : Holdback disabled 1. <i>L o</i> : Deviation low holdback 2. <i>H i</i> : Deviation high holdback 3. <i>b a n d</i> : Deviation band holdback	—	R/W
97	DLT <i>d l l t</i>	Duration time for dwell segment	Low: 0 High: 99.59	—	R/W
98	SEG <i>S E G</i>	Target segment number for the jump segment	Low : 0 High:15(PROF=1~4) 31(PROF=5~7) 63(PROF=8,9)	—	R/W
99	CYCL <i>C Y C L</i>	Repeat number of cycles for the jump and end segment	Low: 1 High: 9999 10000 =, <i>i n F</i> , : infinite	—	R/W
100	FSP <i>F S P</i>	Final set point for the end segment	Low: SPLO High: SPHI	—	R/W
101	OFSTL	Offset value for low point calibration	Low: -1999 high: 1999	0	R/W
102	OFSTH	Offset value for high point calibration	Low: -1999 high: 1999	0	R/W
103	ADLO	mV calibration low coefficient	Low: -1999 high: 1999	—	R/W
104	ADHI	mV calibration high coefficient	Low: -1999 high: 1999	—	R/W

Register Address	Parameter Notation	Parameter Description	Range	Default Value	Data type
105	RTDL	RTD calibration low coefficient	Low: -1999 high: 1999	—	R/W
106	RTDH	RTD calibration high coefficient	Low: -1999 high: 1999	—	R/W
107	CJLO	Cold junction calibration low coefficient	Low: -5.00 high: 40.00	—	R/W
108	CJHI	Cold junction calibration high coefficient	Low: -1999 high: 1999	—	R/W
109	DATE	Date code	Low: 0 High: 3719 (9C31)	—	R/W
110	SRNO	Serial number	Low: 0 High: 9999	—	R/W
111		Reserved			
112	BPL1	Bumpless transfer value of MV1	Low: 0 High: 100.00	—	R
113	BPL2	Bumpless transfer value of MV2	Low: 0 High: 100.00	—	R
114	CJCL	Sense voltage during cold junction calibration low	Low: 0 High: 7552	—	R
115	CALO	Input signal value during low point calibration	Low: -32768 High: 32767	0	R
116	CAHI	Input signal value during high point calibration	Low: -32768 High: 32767	1000	R
117	CAIN	Input sensor calibrated	Low: 0 High: 20	20	R
118		Reserved			
119		Reserved			
120		Reserved			
121		Reserved			
122		Reserved			



Register Address	Parameter Notation	Parameter Description	Range	Default Value	Data type
123		Reserved			
124		Reserved			
125		Reserved			
126		Reserved			
127	MAEO	Manual event output	Low: 000 High: 111	—	R/W
128	PV	Process value	Low: -32768 High: 32767	—	R
129	SV	Set point value for control	Low: SPLO High: SPHI	—	R
130	MV1 H _ _ _	Output 1 percentage value (Heating)	Low: 0.00 High: 100.00	—	*1
131	MV2 [_ _ _	Output 2 percentage value (Cooling)	Low: 0.00 High: 100.00	—	*1
132	STAT	Mode and operation status word	Bit 0 = Profile run mode Bit 1 = Profile hold mode Bit 2 = Static mode Bit 3 = Automatic tuning mode Bit 4 = Manual mode Bit 5 = Off mode Bit 6 = Failure mode Bit 7 = Profile running up Bit 8 = Profile runing down Bit 9 = Profile soaking Bit 10 = Alarm 1 active Bit 11 = Alarm 2 active Bit 12 = Alarm 3 active Bit 13 = Event 1 on Bit 14 = Event 2 on Bit 15 = Event 3 on	—	R
133	EROR	Error Code	Low: 0 High: 40	—	R
134	PFSG	Current profile and segment runing	Low: 1.00 High: 9.63	—	R
135	TNSG	Total number of segments	Low: 1 High: 64	—	R
136	TTSG	Total time for segment runing	Low: 0 High: 99.59	—	R

Register Address	Parameter Notation	Parameter Description	Range		Default Value	Data type
137	SPSG	Set point for current segment	Low:SPLO	High: SPHI	—	R
138	TIME	Time remaining for the current segment	Low:00.00	High: 99.59	—	R
139	CYCL	Cycle remaining for the current loop	Low:1	High: 9999 10000=infinite	—	R
140	PROG	Program and version code of the product	Low: -32768	High: 32767	—	R
141	HBTR	Holdback time remaining for the current segment	Low: 0	High: 99.59	—	R
142	CMND	Command code	Low: -32768	High: 32767	—	R/W
143	JOB	Job code	Low: -32768	High: 32767	—	R/W

*1 Read only unless in manual control mode.

Chapter 2 Installation

 Dangerous voltages capable of causing death are sometimes present in this instrument. Before installation or beginning any cleaning or troubleshooting procedures the power to all equipment must be switched off and isolated. Units suspected of being faulty must be disconnected and removed to a properly equipped workshop for testing and repair. Component replacement and internal adjustments must be made by a qualified maintenance person only.

 This instrument is protected throughout by Double Insulation . To minimize the possibility of fire or shock hazards, do not expose this instrument to rain or excessive moisture.

 Do not use this instrument in areas under hazardous conditions such as excessive shock, vibration, dirt, moisture, corrosive gases or oil. The ambient temperature of the areas should not exceed the maximum rating specified in Chapter 6.

 Remove stains from this instrument using a soft, dry cloth. Don't use harsh chemicals, volatile solvent such as thinner or strong detergents to clean the instrument in order to avoid deformation or discoloration.

2-1 Unpacking

Upon receipt of the shipment remove the unit from the carton and inspect the unit for shipping damage.

If any damage due to transit, report and claim with the carrier.

Write down the model number, serial number, and date code for future reference when corresponding with our service center. The serial number (S/N) and date code (D/C) are labeled on the box and the housing of control.

2-2 Mounting

Make panel cutout to dimension shown in Figure 2.1.

Take both mounting clamps away and insert the controller into panel cutout. Install the mounting clamps back. Gently tighten the screws in the clamp till the controller front panels is fitted snugly in the cutout.

Figure 2.1 Mounting Dimensions

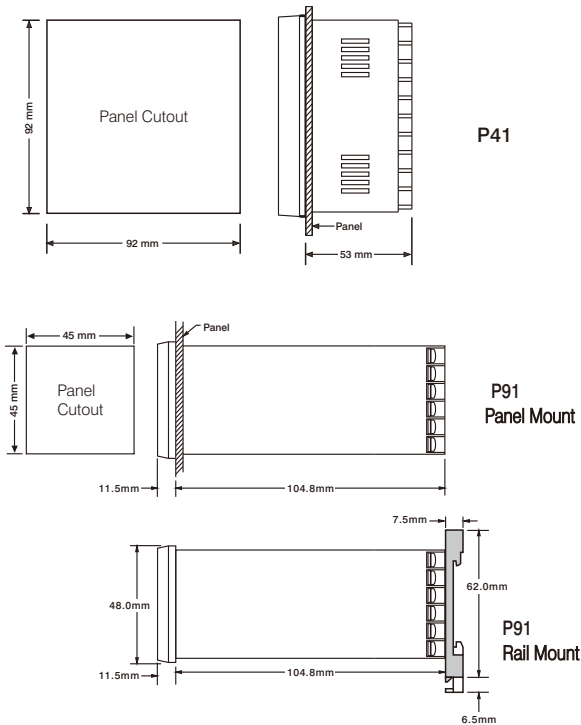

2 - 3 Wiring Precautions

- * Before wiring, verify the label for correct model number and options. Switch off the power while checking.
- * Care must be taken to ensure that maximum voltage rating specified on the label are not exceeded.
- * It is recommended that power of these units to be protected by fuses or circuit breakers rated at the minimum value possible.
- * All units should be installed inside a suitably grounded metal enclosure to prevent live parts being accessible from human hands and metal tools.
- * All wiring must conform to appropriate standards of good practice and local codes and regulations. Wiring must be suitable for voltage, current, and temperature rating of the system.
- * Beware not to over-tighten the terminal screws. The torque should not exceed 1 N-m (8.9 Lb-in or 10.2 KgF-cm), temperature Min. 60°C, use copper conductors only.
- * Unused control terminals should not be used as jumper points as they may be internally connected, causing damage to the unit.
- * Verify that the ratings of the output devices and the inputs as specified in Chapter 6 are not exceeded.
- * Except the thermocouple wiring, all wiring should use stranded copper conductor with maximum gauge 18 AWG.

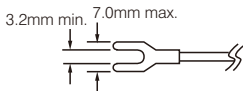

Figure 2.2 Lead Termination for P41

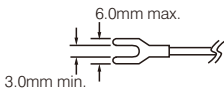
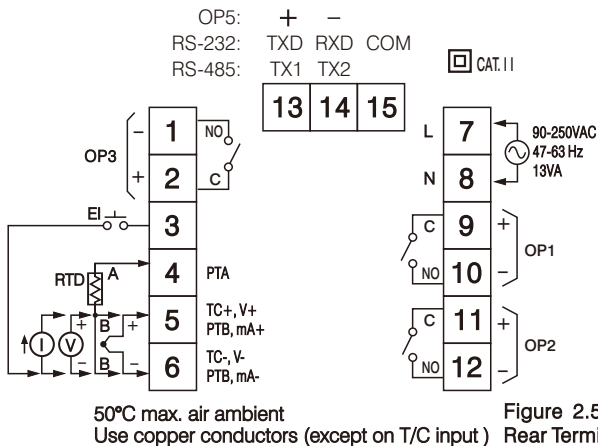
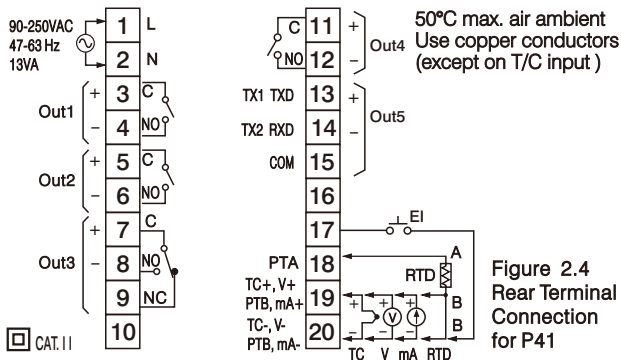

Figure 2.3 Lead Termination for P91



2 - 4 Power Wiring

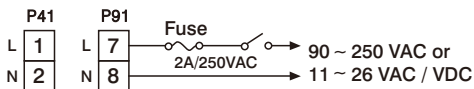

Figure 2.6 Power Supply Connections

2-5 Sensor Input Wiring

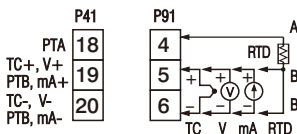

Figure 2.7 Sensor Input Wiring

2-6 Control Output Wiring

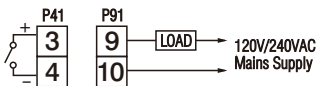

Figure 2.8
Output 1 Relay or Triac (SSR) to Drive Load

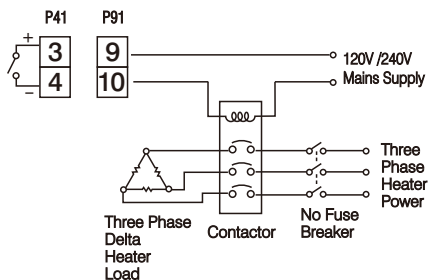

Figure 2.9
Output 1 Relay or Triac (SSR) to Drive Contactor

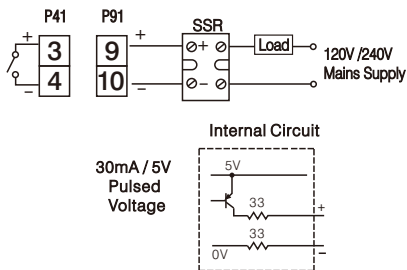

Figure 2.10 Output 1 Pulsed Voltage to Drive SSR

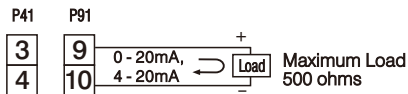

Figure 2.11 Output 1 Linear Current

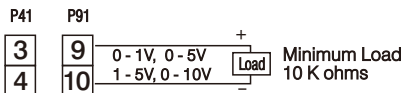

Figure 2.12 Output 1 Linear Voltage

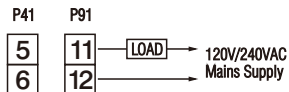

Figure 2.13
Output 2 Relay or Triac (SSR) to Drive Load

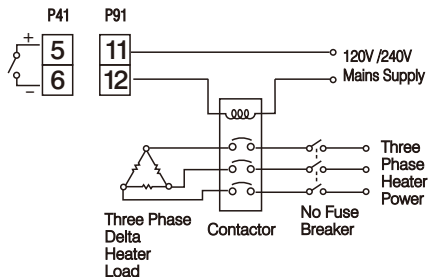

Figure 2.14 Output 2 Relay or Triac (SSR) to Drive Contactor

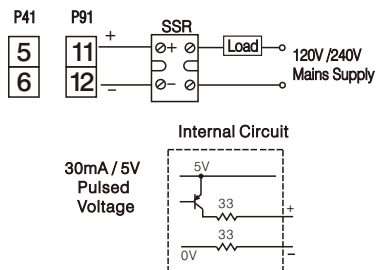

Figure 2.15 Output 2 Pulsed Voltage to Drive SSR

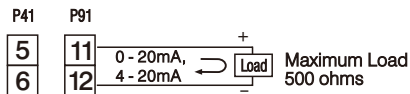

Figure 2.16 Output 2 Linear Current

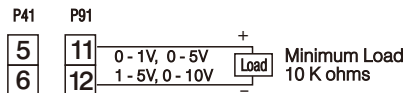

Figure 2.17 Output 2 Linear Voltage

2-7 Alarm / Event Output Wiring

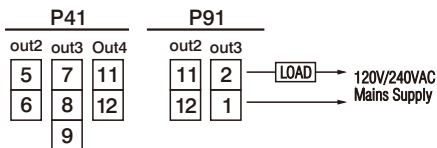

Figure 2.18 Alarm / Event output wiring

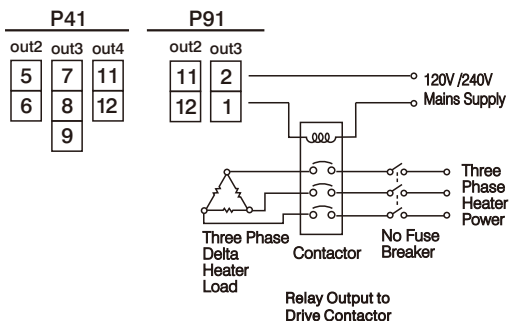

Figure 2.19 Alarm Output to Drive Contactor

2-8 Event Input Wiring

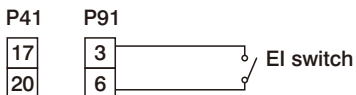

Figure 2.20 Event Input wiring

2-9 Retransmission Output Wiring

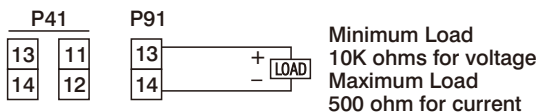

Figure 2.21 Retransmit 4-20 / 0-20 mA Wiring

2-10 Data Communication

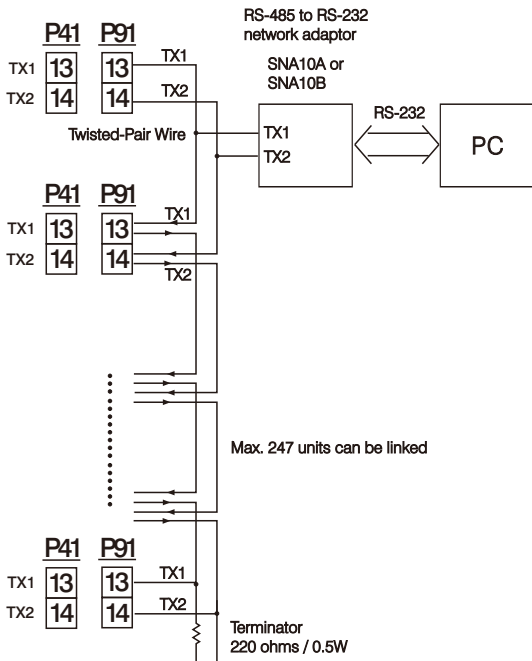

Figure 2.22 RS-485 Wiring

RS-232

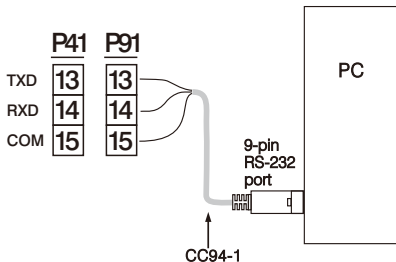

Figure 2.23
RS-232 Wiring

If you use a conventional 9-pin RS-232 cable instead of CC94-1, the

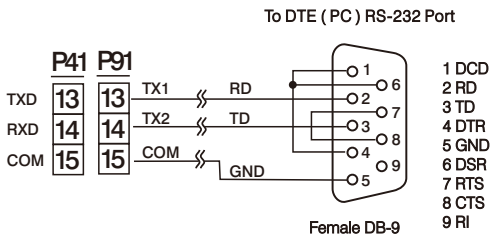





Figure 2.24
Configuration of RS-232 Cable

Chapter 3 Configuration

The parameters stored in Home page can be obtained by pressing scroll key . The parameters stored in Configuration page are obtained by pressing page key  2 times until the display shows *PrOF*, then press page key  for at least 5 seconds and release to show *LoNF* - the Configuration page, then press scroll key to get the configuration parameter. The upper display indicates the parameter symbol, and the lower display indicates the selected value of parameter.

3-1 Password

There are two parameters which specify the data security function, these are PASS (password) and CODE (security code).

Value of CODE	Value of PASS	Results
0	Any value	All parameters are changeable
1000	= 1000	All parameters are changeable
	≠ 1000	Only Home page parameters are changeable
Others	= CODE	All parameters are changeable
	≠ CODE	All parameters are not changeable

Table 3.1 Password operation

3-2 Signal Input

INPT: Selects the sensor type or signal type for signal input.

Range: (thermocouple) J_TC, K_TC, T_TC, E_TC, B_TC, R_TC, S_TC, N_TC, L_TC, C_TC, P_TC.
(RTD) PT.DN, PT.JS
(linear) 4-20, 0-20, 0-60, 0-1V, 0-5V, 1-5V, 0-10

UNIT: Selects the process unit

Range: °C, °F, PU(process unit). If the unit is neither °C nor °F, then selects PU.

DP: Selects the resolution of process value.

Range: (for T/C and RTD) NO.DP, 1-DP
(for linear) NO.DP, 1-DP, 2-DP, 3-DP

INLO: Selects the low scale value for the linear type input.

INHI : Selects the high scale value for the linear type input.

How to use INLO and INHI :

If 4 - 20 mA is selected for INPT, let SL specifies the input signal low (ie. 4 mA), SH specifies the input signal high (ie. 20 mA), S specifies the current input signal value, the conversion curve of the process value is shown as follows :

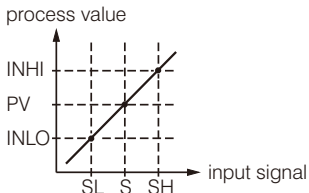

Figure 3.1
Conversion Curve for
Linear Type Process Value

$$\text{Formula : } PV = INLO + (INHI - INLO) \frac{S - SL}{SH - SL}$$

Example : A 4-20 mA current loop pressure transducer with range 0 - 15 kg/cm² is connected to input, then perform the following setup :

INPT = 4 - 20 INLO = 0.00

INHI = 15.00 DP = 2-DP

Of course, you may select other value for DP to alter the resolution.

3-3 Event Input

The Event input accepts a digital type signal via momentary and close contacts. The types of signal :

(1) relay or switch contacts, (2) open collector pull low and (3) TTL logic level, can be used to switch the event input. one of eight functions can be chosen by using E_i , F_n (EIFN) contained in configuration page.

0 NONE : Event input no function

1 RUN : Applicable when unit is in static mode or Off mode

Requires only momentary type input

Event input close: unit will enter run mode

- 2 HOLD : Applicable when unit is running
 Event input close: Hold the profile
 Event input open: Run profile again. Resume from the segment where it hold earlier
- 3 ABOT: Applies when unit is in run mode
 Requires only momentary type input
 Event input close: Unit will abort the current running profile and enter static mode.
- 4 MAN: Applies when unit is in static mode or run mode
 Event input close: Outputs performs bumpless transfer
 Event input open: Unit will perform normal PID operation
- 5 FTRA: Applies when unit is in static mode or run mode
 Event input close: Performs failure transfer function
 Event input open: Unit will perform normal PID operation
- 6 OFF: Applies when unit is in static mode or run mode
 Event input close: All outputs/alarm turn off, profile stops running
 Event input open: If running, profile resumes where it was put into off condition, outputs/alarms active again as per configuration
- 7 PASS: Applies when unit is run mode
 Requires only momentary type input to pass to next segment
 If Event input close the Profile will move the PB2, TI2 and TD2 will replace PB1, TI1 and TD1 for control.
- 8 PID2: Applies when unit is in static mode or run mode

3-4 Control Outputs

There are five types of control modes can be configured as shown in Table 3.2.

Control Modes	OUT1	OUT2	O1HY	A1HY	CPB	DB
Heat only	H_{ONF} H_{LPC} $H_{L,n}$	×	☆	×	×	×
Cool only	C_{ONF} C_{LPC} $C_{L,n}$	×	☆	×	×	×
Heat: ON-OFF Cool: ON-OFF	H_{ONF}	$AL_{\bar{n}1}$	○	○	×	×
Heat: PID Cool: ON-OFF	H_{LPC} $H_{L,n}$	$AL_{\bar{n}1}$	×	○	×	×
Heat: PID Cool: PID	H_{LPC} $H_{L,n}$	C_{LPC} $C_{L,n}$	×	×	○	○

☆:Required to adjust if ON-OFF control is configured.

○ :Adjust to meet process requirements × : Don't care

Table 3.2 Heat-Cool control configuration value

Heat Only ON-OFF Control : Select H_{ONF} for OUT1 and O1HY is used for adjusting the dead band of ON-OFF control. The heat only on-off control function is shown in the following diagram.

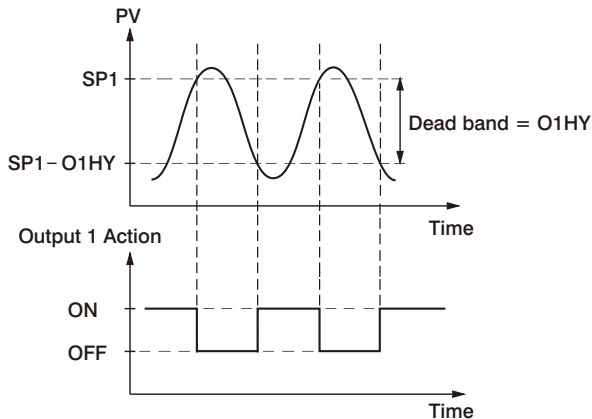

Figure 3.2 Heat Only ON-OFF Control

The ON-OFF control may introduce excessive process oscillation even if hysteresis is minimized to the smallest. If ON-OFF control is set, PB1, TI1, TD1, PB2, TI2, TD2, CYC1, CYC2, OFST, CPB and DB will be hidden and have no function to the system. The auto-tuning mode and bumpless transfer will be disabled too.

Heat only P (or PD) control : Select *HEPC* or *HL_{in}* for OUT1 and set TI1 and TI2 to ZERO, OFST is used to adjust the control offset (manual reset). 01HY is hidden. **OFST Function** : OFST is measured by % with range 0 - 100.0 %. In the steady state (ie. the process has been stabilized) if the process value is lower than the set point by a definite value, say 5 °C, while 20 °C is used for proportional band, that is lower than set point by 25 %, then increase OFST value by 25 % will compensate the process offset situation. After adjusting OFST to a correct value, the process value will move to coincide with set point. The auto-tuning mode is disabled for P or PD control. Refer to section 3-11 for manual tuning. P or PD control is not perfect because the load may change from time to time and you need to adjust OFST often. The PID control can avoid this defect.

Heat only PID control : Set $HLPC$ or $HLIn$ for OUT1 and non-zero value of proportional band and integral time. Perform auto-tuning to the new process, or set correct values for PB1, TI1 and TD1. If the control result is still unsatisfactory, then perform manual tuning to improve the control. See section 3-11 for manual tuning. The unit contains a very clever PID and fuzzy algorithm to achieve a very small overshoot and very quick response to the process if it is tuned properly.

Cool only control: ON-OFF control, P (or PD) control and PID control can be selected for cool only control through Output 1. Set OUT1 to $CONF$, $CLPC$ or $CLIn$, the other functions for cool only ON-OFF control, cool only P (PD) control and cool only PID control are same as descriptions for heat only control except that the output variable (and action) for the cool control is inverse to the heat control.

Heat - Cool control: Three types of combination for heat-cool control are available as shown in table 3. 1. The case1 ~ case3 in Fig 3.3 show the heat PID and cool PID operation. The case 4 show the heat PID and cool ON-OFF operation.

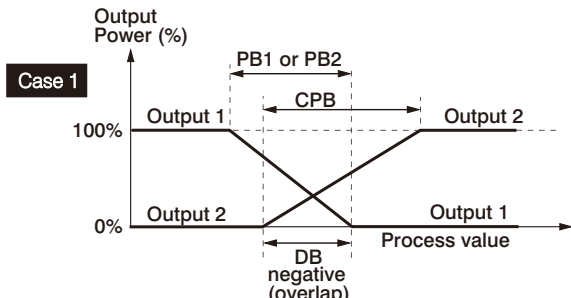

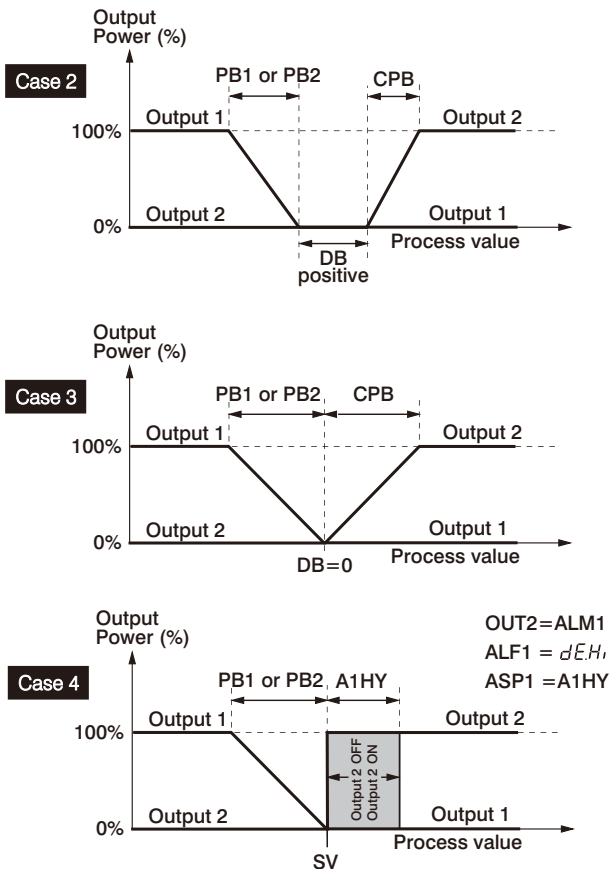

Figure 3.3 Heat - cool Control

CPB Configuration : The cooling proportional band is measured by % of PB with range 50~300. Initially set 100% for CPB and examine the cooling effect. If cooling action should be enhanced then decrease CPB, if cooling action is too strong then increase CPB. The value of CPB is related to PB and its value remains unchanged throughout the auto-tuning procedures.

Adjustment of CPB is related to the cooling media used. For air is used as cooling media, adjust CPB at 100%. For oil is used as cooling media, adjust CPB at 125%. For water is used as cooling media, adjust CPB at 250%.

DB Configuration: Adjustment of DB is dependent on the system requirements. If more positive value of DB (greater dead band) is used, an unwanted cooling action can be avoided but an excessive overshoot over the set point will occur. If more negative value of DB (greater overlap) is used, an excessive overshoot over the set point can be minimized but an unwanted cooling action will occur. It is adjustable in the range -36.0% to 36.0 % of PB. A negative DB value shows an overlap area over which both outputs are active. A positive DB value shows a dead band area over which neither output is active.

NOTE : The ON-OFF control may result excessive overshoot and undershoot problems in the process. The P (or PD) control will result in a deviation process value from the set point. It is recommended to use PID control for the Heat-Cool control to produce a stable and zero offset process value.

Other configuration required: CYC1, CYC2, O1FT and O2FT
CYC1 is adjusted according to the type of output device. Generally, select 0.5~2 sec. for CYC1 if solid state relay drive or solid relay is installed for output1, 10~20 sec. if relay is installed for output1 and CYC1 is ignored if linear output is selected. Similar condition is applied for CYC2 selection.

See **section 3-9** for O1FT and O2FT adjustment.

3-5 Alarms

The unit can be configured up to three alarm outputs at OUT2, OUT3 and OUT4. There are 9 types of alarm functions can be selected, and 4 kinds of alarm modes are available for each alarm function.

P_UH₁ : A process high alarm is independent of set point. When the process is higher than the alarm value, a process high alarm occurs, and the alarm is off as the process value is lower than alarm value - (minus) alarm hysteresis. Fig. 3.4 shows the process high alarm operation.

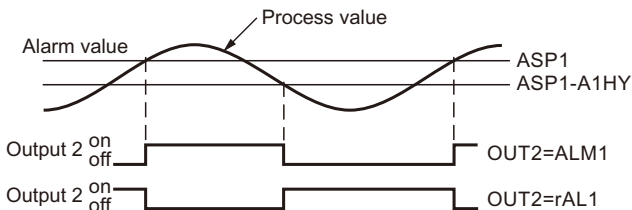

Figure 3.4 Process high alarm 1 operation

P_UL₁ : A Process low alarm is independent of set point. When the process is lower than the alarm value, a process low alarm occurs, and the alarm is off as the process value is higher than alarm value + alarm hysteresis. Fig. 3.5 shows the process low alarm operation.

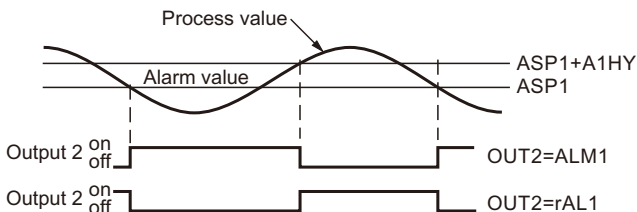

Figure 3.5 Process low alarm 1 operation

dE.H₁ : A deviation high alarm alerts the operator when the process deviates too high from set point value. When the process is higher than $SV+ASP1$, a deviation high alarm occurs and the alarm is off as the process is lower than $SV+ASP1-A1HY$. Figure 3.6 shows the deviation high alarm operation.

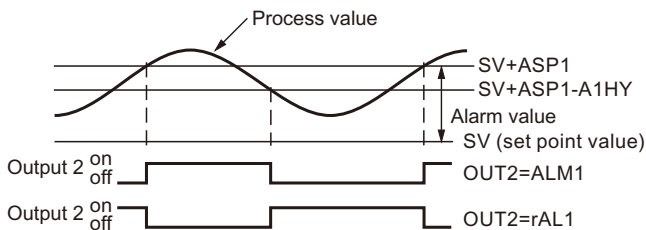

Figure 3.6 Deviation high alarm 1 operation

dE.L₁ : A deviation low alarm alerts the operator when the process deviates too low from set point value. When the process is lower than $SV+ASP1$ ($ASP1$ is negative value), a deviation low alarm occurs, and the alarm is off as the process is higher than $SV+ASP1+A1HY$. Figure 3.7 shows the deviation low alarm operation.

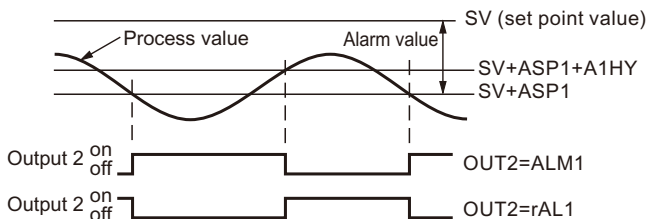

Figure 3.7 Deviation low alarm 1 operation

dbHL : A deviation band high/low alarm presets two trigger levels relative to set point value. The two trigger levels are $SV+ASP1$ and $SV-ASP1$ for alarm. When the process is higher than $SV+ASP1$ or lower than $SV-ASP1$, a deviation band alarm occurs. When the process is within the trigger levels $SV+ASP1-A1HY$ and $SV-ASP1+A1HY$ (where $ASP1$ must be positive value). Figuree 3.8 shows the deviation band alarm 1 operation.

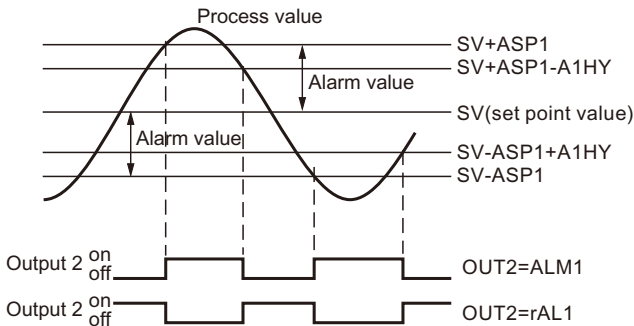



Figure 3.8 Deviation band alarm 1 operation

The above description is based on alarm 1 which is selected for output 2, the operations of alarm 2 and alarm 3 are same as alarm1. In the above description SV denotes the current set point value for control which is different from SP1 as the profile mode is performed.

The alarm modes (A1MD, A2MD and A3MD) are set by using a three bit of binary number.

alarm mode value	Description
<i>nor\bar{n}</i>	A direct acting normal alarm output is off as the non-alarm condition and on as an alarm condition. The output state is inverted as a reverse alarm output is selected for OUT2, OUT3 or OUT4.
<i>Ltch</i>	A direct acting latching alarm output is on as an alarm condition and it will remain unchanged even if the alarm condition is cleared. The output state is inverted as a reverse alarm output is selected for OUT2, OUT3 or OUT4.
<i>HoLd</i>	A direct acting holding alarm output is off even if an alarm condition may occur on power up. This will prevail until the alarm condition returns to the "inactive" condition, thereafter the alarm will operate normally. The output state is inverted as a reverse alarm output is selected for OUT2, OUT3 or OUT4.
<i>LtHo</i>	A direct acting latching and holding alarm performs both holding and latching alarm functions. The output state is inverted as a reverse alarm output is selected for OUT2, OUT3 or OUT4.

Table 3.3 Alarm mode description

The latching alarm output is off when both  and  keys are pressed, once the alarm condition is removed.

3-6 Configure Home Page

The conventional controllers are designed with a fixed parameter scrolling. This unit has the flexibility for you to select those parameters which are most useful to you and put these parameters in the home page. Hence, you can have a custom home page.

There are up to eight parameters can be selected for home page, these are : SEL1~SEL8 in the configuration page.

There are 19 parameters can be selected for SEL1~SEL8, these are: INPT, UNIT, DP, PB1, TI1, TD1, PB2, TI2, TD2, OFST, O1HY, CYC1, CYC2, CPB, DB, A1HY, A2HY, A3HY, ADDR.

When using the up-down key to select the parameters, you may not obtain all of the above parameters. The number of visible parameters is dependent on the configuration condition. The hidden parameters for a specific application are also deleted from the values of SEL1~SEL8 parameters.

3-7 User Calibration





Each unit is calibrated in the factory before shipment. You still can modify the calibration conditions after shipment.

Purpose of user calibration

The basic calibration of the unit is highly stable and set for life. User calibration allows you to offset the permanent factory calibration to either:

1. Calibrate the unit to meet your reference standard.
2. Match the calibration of the unit to that of a particular transducer or sensor input.
3. Calibrate the unit to suit the characteristics of a particular installation.
4. Remove long term drift in the factory set calibration.

There are two parameters: offset low value **OFSTL** and offset high value **OFSTH** which are adjusted to correct the error of process value.

See section 1-5 for key operation flowchart, press  key until low calibration page is obtained. Send the low signal to the input of unit, then press  key. If the process value (the upper display) is different from the input signal, then you can use  and  keys to change the OFSTL value (the lower display) until the process value is equal to the value you want. Then press and hold  key for 5 seconds. The low point calibration is finished. The similar procedure is applied to high point calibration.

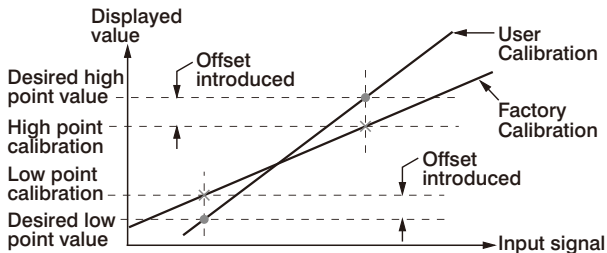

Figure 3.9 Two point user calibration

The two points construct a straight line. For the reason of accuracy it is best to calibrate with the two points as far as possible. After user calibration is complete, the input type will be stored in the memory. If the input type is changed, a calibration error will occur and an error code $[AER]$ is displayed.

3- 8 Digital Filter

In certain application the process value is too unstable to be read. To improve this a programmable low pass filter incorporated in the controller can be used. This is a first order filter with time constant specified by **FILT** parameter . The default value of **FILT** is 0.5 sec. before shipping. Adjust **FILT** to change the time constant from 0 to 60 seconds. 0 second represents no filter is applied to the input

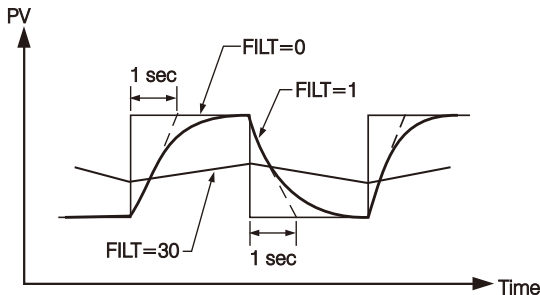

Figure 3.10 Filter Characteristics

Note

The Filter is available only for PV, and is performed for the displayed value only. The controller is designed to use unfiltered signal for control even if Filter is applied. A lagged (filtered) signal,

3 -9 Failure Transfer

The controller will enter **failure mode** as one of the following conditions occurs:

1. **SBER** occurs due to the input sensor break or input current below 1mA if 4-20 mA is selected or input voltage below 0.25V if 1-5 V is selected .
2. **ADER** occurs due to the A-D converter of the controller fails.

The output 1 and output 2 will perform the **failure transfer** function as the controller enters failure mode.

Output 1 Failure Transfer, if activated, will perform :

1. If output 1 is configured as proportional control (ie. HTPC, CTPC, HLIN, or CLIN selected for OUT1,), and BPLS is selected for O1FT, then output 1 will perform bumpless transfer.
Thereafter the previous averaging value of MV1 will be used for controlling output 1.
2. If output 1 is configured as proportional control, and a value of 0 to 100.0 % is set for O1FT, then output 1 will perform failure transfer.
Thereafter the value of O1FT will be used for controlling output 1.
3. If output 1 is configured as ON-OFF control (ie. HONF or CONF is selected for OUT1), then output 1 will transfer to off state if OFF is set for O1FT and transfer to on state if ON is set for O1FT.

Output 2 Failure Transfer, if activated, will perform :

1. If OUT2 is configured as CTPC or CLIN, and BPLS is selected for O2FT, then output 2 will perform bumpless transfer. Thereafter the previous averaging value of MV2 will be used for controlling output 2.
2. If OUT2 is configured as CTPC or CLIN, and a value of 0 to 100.0 % is set for O2FT, then output 2 will perform failure transfer. Thereafter the value of O2FT will be used for controlling output 2.
3. If OUT2 is configured as alarm function, and OFF is set for O2FT, then output 2 will transfer to off state, otherwise, output 2 will transfer to on state if ON is set for O2FT.

OUT3 and OUT4 Failure Transfer is activated as the controller enters failure mode. Thereafter the alarm will transfer to the ON or OFF state which is determined by the set value of O3FT or O4FT..

3-10 Auto-tuning



The auto-tuning process is performed at set point. The process will oscillate around the set point during tuning process. Set a set point to a lower value if overshooting beyond the normal process value is likely to cause damage.

The auto-tuning is applied in cases of :

- * Initial setup for a new process
- * The set point is changed substantially from the previous auto-tuning value
- * The control result is unsatisfactory

Operation :

1. Set the correct values for the configuration page. Nonzero value for PB and TI should be set. Set a correct password for the unit.
2. Set EIFN = PID2 if a second set of PID is required to be tuned.
3. Set the set point to a normal operating value or a lower value if overshooting beyond the normal process value is likely to cause damage. Then enters the A-T mode. The upper display will begin to flash and the auto-tuning procedure for PID1 is beginning.
4. If the system needs to use a second set of PID values, then after the first auto-tuning is complete, close the event input of the unit and repeat the step 3 to the second set of PID values.

NOTE :

The auto-tuning mode is disabled as soon as either failure mode or manual control mode occurs.

Procedures:

The auto-tuning can be applied either as the process is warming up (Cold Start) or as the process has been in steady state (Warm Start).



After the auto-tuning procedures are completed, the upper display will cease to flash and the unit revert to PID control by using its new PID values. The PID values obtained are stored in the nonvolatile memory.

ATER Auto-Tuning Error

If auto-tuning fails an ATER message will appear on the upper display in cases of :

- If PB exceeds 9000 (9000 PU, 900.0 °F or 500.0 °C).
- or if TI exceeds 3600 seconds.
- or if set point is changed during auto-tuning procedure.

Solutions to **ATER**

1. Try auto-tuning once again.
2. Don't change set point value during auto-tuning procedure.
3. Don't set zero value for PB and TI.
4. Use manual tuning instead of auto-tuning. (See section 3-12).
5. Touch  and  key to reset **ATER** message.

3 - 11 Manual Tuning

In certain applications (very few) using auto-tuning to tune a process may be inadequate for the control requirement, then you can try manual tuning.

If the control performance by using auto- tuning is still unsatisfactory, the following rules can be applied for further adjustment of PID values

ADJUSTMENT SEQUENCE	SYMPTOM	SOLUTION
(1) Proportional Band (PB)	Slow Response	Decrease PB
	High overshoot or Oscillations	Increase PB
(2) Integral Time (TI)	Slow Response	Decrease TI
	Instability or Oscillations	Increase TI
(3) Derivative Time (TD)	Slow Response or Oscillations	Decrease TD
	High Overshoot	Increase TD

Table 3.4 PID Adjustment Guide

Figure 3.11 shows the effects of PID adjustment on process response.

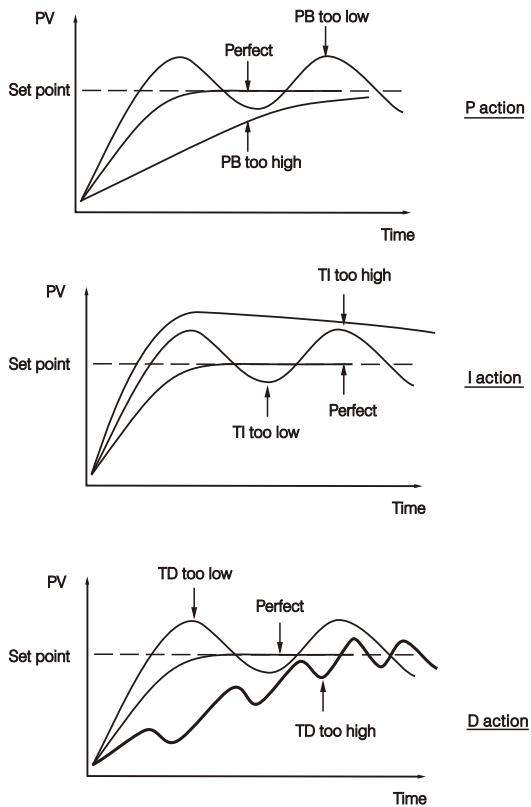









Figure 3.11 Effects of PID Adjustment



3-12 Manual Mode

Operation:

To enable manual control the password PASS should be set with a value equal to CODE (except CODE=0) .

Press  key to get *mode* (mode select), then use  and  keys to obtain *Man* (Man). Then press  key for 5 seconds, the unit now enters the manual mode. The upper display will begin to flash and the lower display will show  or .  indicates control percentage value for heating output and  indicates control percentage value for cooling output. Now you can use up and down key to adjust the percentage values for the heating or cooling output. The controller performs open loop control as long as it stays in manual mode.

Exit Manual Mode

To press both  and  keys , the controller will revert to static mode and show home display.

3 - 13 Data Communication

The controllers support **RTU** mode of **Modbus** protocol for the data communication. Other protocols are not available for the series.

Two types of interface are available for Data Communication. These are RS-485 and RS-232 interface. Since RS-485 uses a differential architecture to drive and sense signal instead of a single ended architecture which is used for RS-232, RS-485 is less sensitive to the noise and suitable for a longer distance communication. RS-485 can communicate without error over 1 km distance while RS-232 is not recommended for a distance over 20 meters.

Using a PC for data communication is the most economic way. The signal is transmitted and received through the PC communication Port (generally RS-232). Since a standard PC can't support RS-485 port, a network adaptor (such as SNA10A, SNA10B) has to be used to convert RS-485 to RS-232 for a PC if RS-485 is required for the data communication. But there is no need to be sad. Many RS-485 units (up to 247 units) can be connected to one RS-232 port, therefore a PC with 4 comm ports can communicate with 988 units. It is quite economic.

Setup

Enters the configuration page.

Select COMM for OUT4 or OUT5 . Set unequal addresses for those units which are connected to the same port.

Set the Baud Rate (BAUD), and Parity Bit (PARI) such that these values are conform to PC setup conditions.

If you use a conventional 9-pin RS-232 cable instead of CC94-1, the cable should be modified for proper operation of RS-232 communication

3 - 14 Retransmission

The profiler can output (retransmit) process value or set point value via its retransmission terminals RE+ and RE- provided that the retransmission option is ordered. To accomplish this you can select *REP* (REPV) or *RESP* (RESP) for OUT4 or OUT5. The following parameters should be configured for retransmission:

OP4L : Low limit value for output 4

OP4H : High limit value for output 4

REL4 : Retransmission low scale value for output 4

REH4 : Retransmission high scale value for output 4

OP5L : Low limit value for output 5

OP5H : High limit value for output 5

REL5 : Retransmission low scale value for output 5

REH5 : Retransmission high scale value for output 5

Example: If you want to output 4 mA for PV at 0 °C and 20mA for PV at 1000 °C via output 5, then you should set the following parameters:

OUT5 = *RESP*

OP5L = 20.0 (%), since 20% of a 0-20mA output module equipped will output 4 mA (20% of 20mA span).

OP5H = 100.0 (%)

REL5 = 0 °C

REH5 = 1000 °C

3 - 15 Output Scaling

The output scaling can be applied to the cases of linear output (case 1 in Fig. 3.12) and retransmission (case 2 in Fig. 3.12). The Out.L in Fig. 3.12 may be 0 mA, 0V, 1V or 4mA, and out.H may be 20mA, 5V or 10V according to the output module installed.

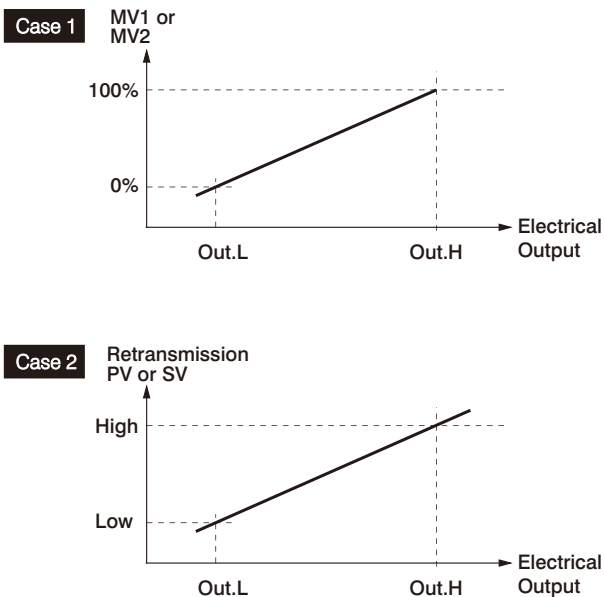

Figure 3.12 Output scaling function

Chapter 4 Profiler Operation

4-1 What is set point profiler

Many applications need to vary temperature or process value with time. Such applications need a controller which varies a set point as a function of time. The profiling controller P41 and P91 can do this.

The set point is varied by using a set point profiler. The profile is stored as a series of "ramp" and "dwell" segments, as shown below.

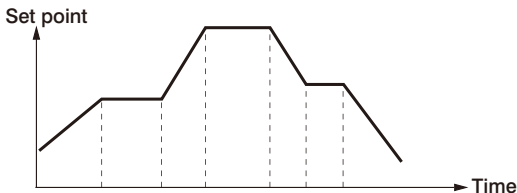

Figure 4.1 Set point profile

In each segment you can define the state of up to 3 event outputs which can drive either relay, logic or triac outputs, depending on the modules installed.

A profile is executed either once, repeated a set number of times or repeated continuously. If repeated a set number of times, then the number of cycles must be specified as part of the profile.

There are four types of segment:

Ramp		The set point ramp linearly, from its current value to a new value, either at a rate (ramp rate), or in a set time ramp time). you must specify the ramp rate or the ramp time and the target set point when creating or modifying a profile.
Dwell		The set point remains constant for a specified period.
Jump		It is often necessary to jump backward and run the loop a set number of cycles.
End		The profile either ends in this segment or repeats a set number of cycles. The profile stops after the repeated cycles are finished.

Table 4.1 Segment types

4-2 Segment connection

Four kinds of combination are allowable for connecting segments, these are:

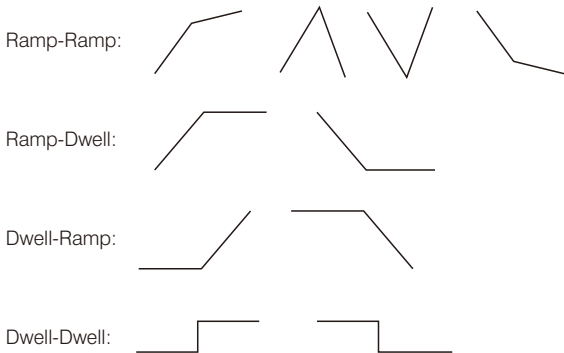

4-3 Profiler Modes

The profile have eight operating modes:

Mode	Description	Indication
Run	In run mode, the profiler varies the set point according to the stored profile values.	RUN light on
Hold	In hold mode, the profile is frozen at its current point. In this state you can make temporary changes to any profile parameter(for example, a target set point, a dwell time or the time remaining in the current segment). Such changes will only remain effective until the profile is reset and run again, when they will be overwritten by the stored profile values.	HLD light on

Mode	Description	Indication
Holdback	Holdback indicates that the process value is lagging the set point by more than a preset amount (holdback band HBBB) and that the profile is in HOLD, waiting for the process to catch up.	HLD light flashes
Static	In static mode, the profiler is inactive and the controller act as a standard controller, with the set point determined by the value set in the lower display.	Both RUN and HLD light are off
A-T	In automatic tuning mode, the profiler is inactive and the controller executes automatic tuning function at its static mode set point.	Both RUN and HLD light are off. Upper display flashes.
MAN	In manual mode, the profiler is inactive and the heating and cooling output values can be adjusted at the lower display by up-down keys.	Both RUN and HLD light are off. Upper display flashes. Lower display shows H_{---} or C_{---}
OFF	In off mode, the profiler is inactive and all the outputs are disabled. That is all the control outputs, alarms and event outputs are off.	Both RUN and HLD light are off. Upper display shows OFF and flashes.
End	The profile is complete.	Both RUN and HLD lights flash.

Table 4.2 Profiler Modes

4-4 Running, holding and aborting a profile

Press page key until mode page is obtained. The upper display will show n_{oDE} and the lower display is the values for mode selection. By using up/down key until run is obtained. Press page key for 5 seconds then the profiler enters RUN mode. If $HoLd$ is obtained, pressing the page key for 5 seconds will enter HOLD mode.

The operator may abort (i.e. terminate) the current profile by holding page key for more than 5 seconds during the lower display shows *SETE* . When the program is aborted, the profiler is inactive and enters static mode. At the same time both the RUN light and HLD light are off.

If "RUN" and "HLD" LED's are blinking simultaneously, it indicates the end of previous running profile, it requires to Reset profile controller by pressing UP and DOWN keys together to take Profile start segment, PFSG=1.00. Select the profile and segment by pressing Enter Key. P 1.00 indicates profile 1 and segment 00 is selected.

Please refer to **section 1-5** for key operation.

4-5 Viewing and modifying profile progress

Three parameters: PFSG, TIME, CYCL which indicate the status of profile progress. The operator can easily view these parameters: the current profile and segment number, the time remaining for the current segment and the cycle remaining for the current profile on the home page.

When profile is running, if is required to jump to another segment, then it requires holding of current profile, go to current segment PSEG by pressing "Enter" button, then use "Up" and "Down" buttons to modify the segment and then run the profile again.

When profile is running, if it is required to change dwell time or ramp rate of current segment, then it requires holding of current profile, press "Enter" button, twice to go to "TIME" and then modify the value and then run the profile again.

When profile is running, if it is required to modify next segment data, no need to hold the current profile, modifications can be done directly from the configuration

4-6 Start

The parameter "St Ar" in the configuration is used to specify the start point for the profile.

There are three values for the starting point, these are

PV: Process value (default value)

SP1 :controller set point value

STSP: start set point value

The normal method is to start from the process value, because this will produce a smooth and bumpless start to the process. However, if you want to guarantee the time period of the first segment, you should set SP1 or STSP for the start point

4-7 Holdback

As the set point ramps up or down (or dwells), the measured value may lag behind or deviate from the set point by an undesirable amount. "Holdback" is available to freeze the profile at its current state, should this occur. The action of Holdback is the same as a deviation alarm. It can be enabled or disabled. Holdback has three parameters: **HBT**-holdback wait time, **HBB**-holdback band and **HBTY**-holdback type. If the error from the set point exceeds the set holdback band (HBB), then the holdback feature, if enabled, will automatically freeze the profile at its current point and flash the HLD light. At the same time, the holdback timer begins to count. When the value of holdback timer exceeds the value of holdback wait time HBT, the profiler will no longer be frozen and jump to its next segment, at the same time an error code *HbEr* will be displayed. When the error comes within the holdback band (HBB), the program will resume normal running. There are four different Holdback types. The choice of type is made by setting HBTY parameter when creating a profile, and may be one of the following:

- oFF* - Disables Holdback - no action is taken.
- L o* - Deviation Low Holdback holds the profile back when the process value deviates below the set point by more than the holdback band (HBB).
- H i* - Deviation high holdback holds the profile back when the process value deviates above the set point by more than the holdback band (HBB).
- bRnd* - Deviation Band Holdback is a combination of the two. It holds the profile back when the process value deviates either above or below the set point by more than the holdback band (HBB).
HBT is a global parameter which is common to all profiles. HBB is a parameter which apply to a specific profile. HBTY is a parameter which apply to a segment in a specific profile.

Holdback on dwell

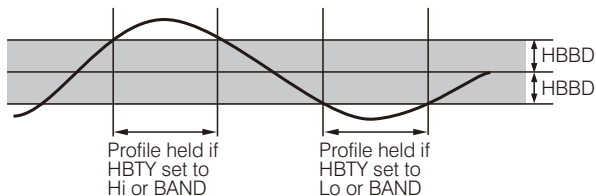

Holdback on positive ramp

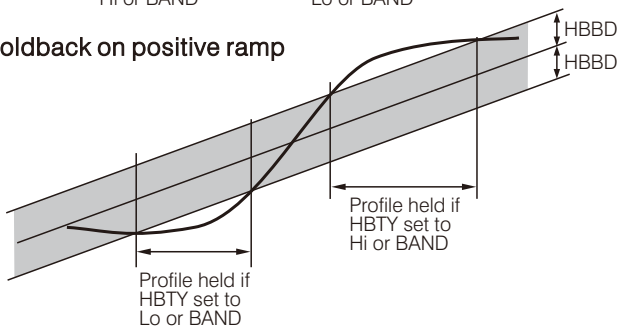

Holdback on negative ramp

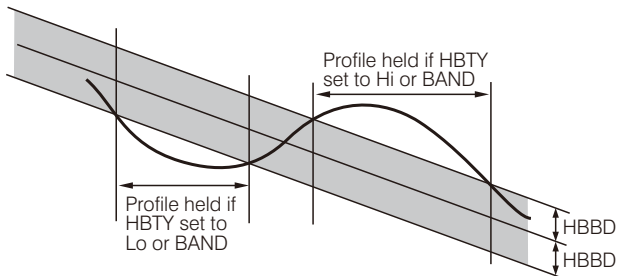

Figure 4.2 Holdback operation

4-8 Power failure

If power is lost and then restored, while a profile is running, the behavior of the profile is determined by the setting of the parameter " PFR " power fail recovery in profile configuration. This can have one of 4 settings - *cont* , *PU* , *SP I* and *OFF* . If *cont* is selected, then when power is restored the profile continues from where it was interrupted when power was lost. The parameters such as set point value (SV), time remaining (TIME) and cycle remaining (CYCL) will be restored to their power-down values. For application that need to bring the process value to the set point value as soon as possible, this is the best choice. The two diagrams below illustrate the respective responses, Fig. 4.3 if power fails during a dwell segment and Fig. 4.4 if it fails during a ramp segment.

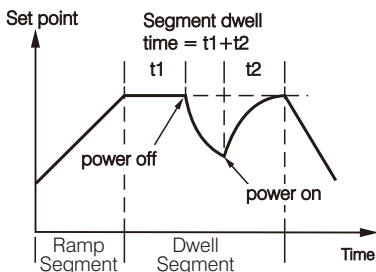

Figure 4.3 Recovery from profile at dwell segment

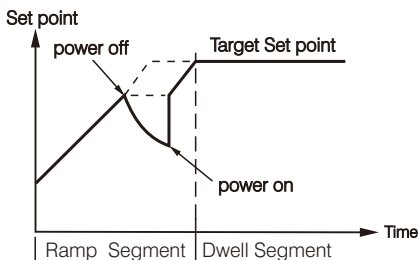

Figure 4.4 Recovery from profile at ramp segment

If PV is selected, then when power is restored the set point starts at the current process value, and then runs to the target set point of the active segment. This choice provides a smoother recovery. The two diagrams below illustrate the respective responses, Fig. 4.5 if power fails during a dwell segment and Fig. 4.6 if it fails during a ramp segment.

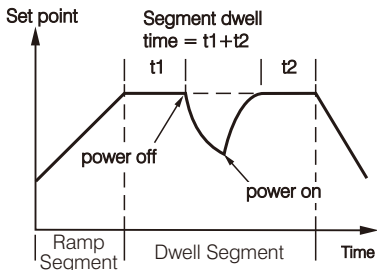

Figure 4.5 Recovery from PV at dwell segment

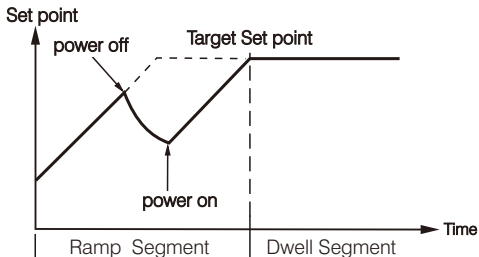

Figure 4.6 Recovery from PV at ramp segment

If $SP1$ is selected, then when power is restored the profiler is disabled and it enters static mode, and $SP1$ is selected for control set point. If OFF is selected, then when power is restored the profiler is disabled and it enters OFF mode, all the control outputs as well as alarms and events are off.

4-9 Configuring the profiler

when first installing a profiler you should check that the configuration conforms to your requirement.

The following parameters are common to all profiles:

Global Data

- STAR : set point value at start of profile
- END : set point value at end of profile
- DLAY : Delay time before profile start
- PFR : Power fail recovery
- HBT : Holdback wait time

The following parameters are used for a specific profile:

Profile Data

- PROF : Profile number selected for view
- HBBD : Holdback band
- STSP : Start set point value
- RMPU : Unit for ramp segment
- DLLU : Unit for dwell segment

The following parameters which apply to each segment in a specific profile:

Segment Data

- SGNO : Segment number
- SGTY : Segment type
- TGSP : Target set point
- RTRR : Ramp time or ramp rate
- P2EV : PID selection and event output states
- HBTY : Holdback type
- DLLT : Dwell time
- SEG : Target segment number for jump segment
- CYCL : Repeat number of cycle
- FSP : Final set point for the end segment

4-10 Viewing and creating a profile

Refer to **section 1-5** for key operation. Press page key to obtain configuration page. After completing the configuration of all the parameters including those parameters which are common to all profiles, you can proceed to the profile page to create a profile. To create a specific profile you need to set the profile number at first, then set HBBD, STSP, RMPU, DLLU and SGNO for this profile.

The next parameter is segment type (SGTY). there are four different segment types, these are

- r-RnP* : Ramp to a new set point at a set rate or in a set time
- dLL* : Dwell for a set time
- JuñP* : Jump to a specified segment in the same profile
- End* : Make this segment the end of the profile

The parameters that follow SGTY (segment type) depend on the type of segment selected as shown in the table below. The function of each parameters follows the table.

Parameter	Segment type (SGTY) selected			
	0 RAMP	1 DLL	2 JUMP	3 END
TGSP	✓			
RTRR	✓			
P2EV	✓	✓		
HBTY	✓	✓		
DLT		✓		
SEG			✓	
CYCL			✓	✓
FSP				✓

Table 4.3 Parameters that follow segment type

Suppose that you need a profiler to control a process .The response of the profiler must be same as the figure shown below.

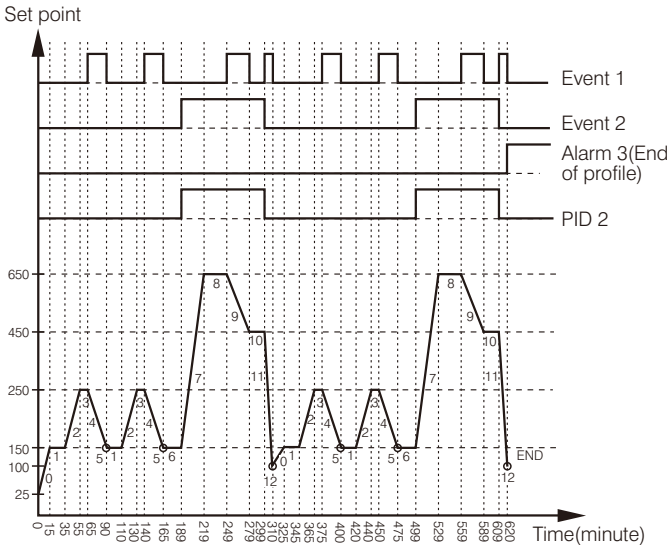

Figure 4.7 Profiling curve example

In order to meet the response of profiling curve example. you can make a series of setting of parameters as follow:

Global Data

STAR = STSP
 END = OFF
 DLAY = 0
 PFR = PV
 HBT = 1.00

Profile Data

PROF = 1
 HBBDD = 50
 STSP = 25.0
 RMPU = HH.MM
 DLLU = HH.MM

Segment Data

SGNO = 0
 SGTY = RAMP
 TGSP = 150.0
 RTRR = 15
 P2EV = 0000
 HBTY = 1

Segment 0

SGNO = 1
 SGTY = DLL
 P2EV = 0000
 HBTY = 3
 DLLT = 20

Segment 1

SGNO = 2
SGTY = RAMP
TGSP = 250.0
RTRR = 20
P2EV = 0000
HBTY = 1

Segment 2

SGNO = 8
SGTY = DLL
P2EV = 1010
HBTY = 3
DLLT = 30

Segment 8

SGNO = 3
SGTY = DLL
P2EV = 0000
HBTY = 3
DLLT = 10

Segment 3

SGNO = 9
SGTY = RAMP
TGSP = 450.0
RTRR = 30
P2EV = 1011
HBTY = 2

Segment 9

SGNO = 4
SGTY = RAMP
TGSP = 150.0
RTRR = 25
P2EV = 0001
HBTY = 2

Segment 4

SGNO = 10
SGTY = DLL
P2EV = 1010
HBTY = 3
DLLT = 20

Segment 10

SGNO = 5
SGTY = JUMP
SEG = 1
CYCL = 2

Segment 5

SGNO = 11
SGTY = RAMP
TGSP = 100.0
RTRR = 11
P2EV = 0001
HBTY = 2

Segment 11

SGNO = 6
SGTY = DLL
P2EV = 0000
HBTY = 3
DLLT = 24

Segment 6

SGNO = 12
SGTY = END
CYCL = 2
FSP = 100.0

Segment 12

SGNO = 7
SGTY = RAMP
TGSP = 650.0
RTRR = 30
P2EV = 1010
HBTY = 1

Segment 7

4-11 Event Outputs and PID Selection

The event outputs and PID selection are defined by parameter P2EV in the segment data and parameters OUT2, OUT3 and OUT4. There are up to 3 event outputs can be configured. The register 95 shown in section 1-6 describes how to define event status and select PID values.

There are two sets of PID parameters stored in the memory. If the unit is in RUN or HOLD mode, the PID sets are selected by the most significant bit of parameter P2EV. If the unit is in STAT mode (static or controller mode), the PID sets are selected by event input function EIFN. If the unit is in A-T mode, then PB1, TI1, TD1 are selected. If the unit is in AT2 mode, then PB2, TI2 and TD2 are selected.

There is a parameter MAEO which allows you to manually turn the output on and off when parameter OUT1, OUT2 or OUT3 is configured as event output. It is a four-bit binary number, 0=inactive, 1=active, the USB is to turn on/off the Event 1, the second bit is to turn on/off the Event 2 and the 3rd bit is to turn on/off the Event 3. This parameter MAEO can be accessed either via communication port or via front key switch and MAEO can be viewed in home page by selecting it in one of SEL1 through SEL8. The parameter MAEO will be not active in the profile mode or off mode, and will be active in static, manual and auto turn modes.

Chapter 5 Applications

A heat treatment oven need to vary temperature as a function of time. Because the process requires a rapid increase of temperature as it is heated and a rapid decrease of temperature as it is cooled. In order to achieve a rapid increase of temperature, an additional heater is turned on at higher range of temperature. A cooling fan is turned on to accelerate the cooling rate as the temperature falls fast. An alarm is required to announce the operator as the procedure is finished. Since the condition is changing when an additional heater is turned on, the PID control parameter should be different from the case of single heater. A P41 profiling controller is perfectly to meet the above requirements. The system diagram is shown below:

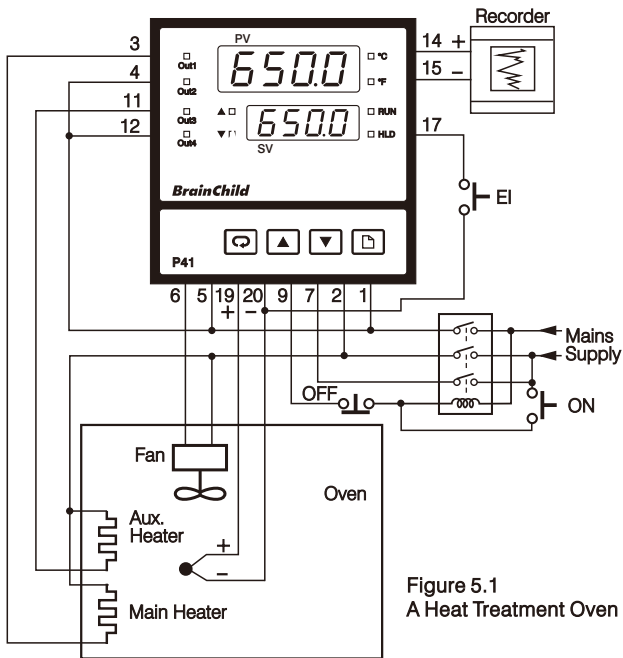

Figure 5.1
A Heat Treatment Oven

The output 1 is used to drive the main heater, The output 2 is used to drive the cooling fan, the output 3 is used for end of profile relay and the output 4 is used to drive the auxiliary heater.

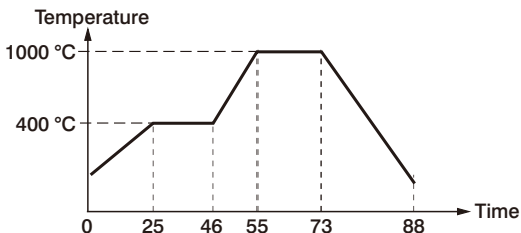

Figure 5.2 Temperature profile of the Heat Treatment Oven

The temperature profile is shown as Fig. 5.2. To achieve this profile, the profiler is configured by the following setting:

Global Data

STAR = PV	SGNO = 2	SGNO = 5
END = OFF	SGTY = DLL	SGTY = RAMP
DLAY = 0	P2EV = 0000	TGSP = 25.0
PFR = CONT	HBTY = 3	RTRR = 15
HBT = 0.05	DLTT = 21	P2EV = 0001
		HBTY = 2

Profile Data

PROF = 1	SGNO = 3	SGNO = 6
HBBD = 50	SGTY = RAMP	SGTY = END
RMPU = HH.MM	TGSP = 1000.0	CYCL = 1
DLTU = HH.MM	RTRR = 9	FSP = 25.0
	P2EV = 1100	
	HBTY = 1	

Segment Data

SGNO = 1	SGNO = 4
SGTY = RAMP	SGTY = DLL
TGSP = 400.0	P2EV = 1100
RTRR = 25	HBTY = 3
P2EV = 0000	DLTT = 18
HBTY = 1	

Controller Configuration Data

ALF2 = ENDP	OUT2 = EVN1
A2MD = 0000	OUT3 = ALM2
INPT = K_TC	OUT4 = EVN3
OUT1 = HTPC	OUT5 = REPV
O1FT = BPLS	OP5L = 0.0
UNIT = °C	OP5H = 100.0
DP = 1_DP	REL5 = 0.0
CYC1 = 18.0	REH5 = 1000.0

Auto-tuning is performed at 400 °C for PID1 and 1000°C for PID2.

Chapter 6 Specifications

Power

90–250 VAC, 47–63 Hz, 13VA, 6W maximum

11–26 VAC / VDC, 13VA, 6W maximum

Input

Resolution : 18 bits

Sampling Rate : 5 times / second

Maximum Rating : -2 VDC minimum, 12 VDC maximum
(1 minute for mA input)

Temperature Effect : $\pm 1.5\mu\text{V}/^\circ\text{C}$ for all inputs except
mA input
 $\pm 3.0\mu\text{V}/^\circ\text{C}$ for mA input

Sensor Lead Resistance Effect :

T/C: $0.2\mu\text{V}/\text{ohm}$

3-wire RTD: $2.6^\circ\text{C}/\text{ohm}$ of resistance difference of two
leads

2-wire RTD: $2.6^\circ\text{C}/\text{ohm}$ of resistance sum of two leads

Burn-out Current : 200 nA

Common Mode Rejection Ratio (CMRR): 120dB

Normal Mode Rejection Ratio (NMRR): 55dB

Sensor Break Detection :

Sensor open for TC, RTD and mV inputs,

Sensor short for RTD input

below 1 mA for 4-20 mA input,

below 0.25V for 1 - 5 V input,

unavailable for other inputs.

Sensor Break Responding Time :

Within 4 seconds for TC, RTD and mV inputs,

0.1 second for 4-20 mA and 1 - 5 V inputs.

Characteristics:

Type	Range	Accuracy @ 25 °C	Input Impedance
J	-120°C-1000°C (-184°F-1832°F)	±2 °C	2.2 MΩ
K	-200°C-1370°C (-328°F-2498°F)	±2 °C	2.2 MΩ
T	-250°C-400°C (-418°F-752°F)	±2 °C	2.2 MΩ
E	-100°C-900°C (-148°F-1652°F)	±2 °C	2.2 MΩ
B	0°C-1800°C (32°F-3272°F)	±2 °C (200°C- 1800°C)	2.2 MΩ
R	0°C-1767.8°C (32°F-3214°F)	±2 °C	2.2 MΩ
S	0°C-1767.8°C (32°F-3214°F)	±2 °C	2.2 MΩ
N	-250°C-1300°C (-418°F-2372°F)	±2 °C	2.2 MΩ
L	-200°C-900°C (-328°F-1652°F)	±2 °C	2.2 MΩ
C	0°C-2315°C (32°F-4199°F)	±2 °C	2.2 MΩ
P	0°C-1395°C (32°F-2543°F)	±2 °C	2.2 MΩ
PT100 (DIN)	-210°C-700°C (-346°F-1292°F)	±0.4 °C	1.3 KΩ
PT100 (JIS)	-200°C-600°C (-328°F-1112°F)	±0.4 °C	1.3 KΩ
mV	-8mV - 70mV	±0.05 %	2.2 MΩ
mA	-3mA-27mA	±0.05 %	70.5 Ω
V	-1.3V-11.5V	±0.05 %	650 KΩ

Output 1 / Output 2

Relay Rating : 2A/240 VAC, life cycles 200,000 for resistive load

Pulsed Voltage : Source Voltage 5V,
current limiting resistance 66 Ω .

Linear Output Characteristics

Type	Zero Tolerance	Span Tolerance	Load Capacity
4~20 mA	3.6~4 mA	20~21 mA	500 Ω max.
0~20 mA	0 mA	20~21 mA	500 Ω max.
0 ~ 5 V	0 V	5 ~ 5.25 V	10 K Ω min.
1 ~ 5 V	0.9 ~ 1 V	5 ~ 5.25 V	10 K Ω min.
0 ~ 10 V	0 V	10 ~10.5 V	10 K Ω min.

Linear Output

Resolution : 15 bits

Output Regulation : 0.02 % for full load change

Output Settling Time : 0.1 sec. (stable to 99.9 %)

Isolation Breakdown Voltage : 1000 VAC

Temperature Effect : ± 0.01 % of SPAN / $^{\circ}\text{C}$

Triac (SSR) Output

Rating : 1A / 240 VAC

Inrush Current : 20A for 1 cycle

Min. Load Current : 50 mA rms

Max. Off-state Leakage : 3 mA rms

Max. On-state Voltage : 1.5 V rms

Insulation Resistance : 1000 Mohms min. at 500 VDC

Dielectric Strength : 2500 VAC for 1 minute

DC Voltage Supply Characteristics (Installed at Output 2)

Type	Tolerance	Max. Output Current	Ripple Voltage	Isolation Barrier
20 V	± 1 V	25 mA	0.2 Vp-p	500 VAC
12 V	±0.6 V	40 mA	0.1 Vp-p	500 VAC
5 V	±0.25 V	80 mA	0.05 Vp-p	500 VAC

Alarm

Alarm Relay : Form C Rating

2A/240VAC, life cycles 200,000 for resistive load.

Alarm Functions : Dwell timer, Deviation High / Low Alarm,
Deviation Band High / Low Alarm,
PV High / Low Alarm,

Alarm Mode : Normal, Latching, Hold, Latching / Hold.

Dwell Timer : 0.1 - 4553.6 minutes

Data Communication

Interface : RS-232 (1 unit), RS-485 (up to 247 units)

Protocol : Modbus Protocol RTU mode

Address : 1 - 247

Baud Rate : 2.4 ~ 38.4 Kbits/sec

Parity Bit : None, Even or Odd

Communication Buffer : 256 bytes

Analog Retransmission

Output Signal : 4-20 mA, 0-20 mA, 0 - 5V,
1 - 5V, 0 - 10V

Resolution : 15 bits

Accuracy : ±0.05 % of span ±0.0025 %/ °C

Load Resistance :

0 - 500 ohms (for current output)

10 K ohms minimum (for voltage output)

Output Regulation : 0.01 % for full load change

Output Settling Time : 0.1 sec. (stable to 99.9 %)
Isolation Breakdown Voltage : 1000 VAC min.
Integral Linearity Error : ± 0.005 % of span
Temperature Effect : ± 0.0025 % of span/ °C
Saturation Low : 0 mA (or 0V)
Saturation High : 22.2 mA (or 5.55V, 11.1V min.)
Linear Output Range : 0-22.2mA(0-20mA or 4-20mA)
0-5.55V (0 - 5V, 1 - 5V)
0 - 11.1 V (0 - 10V)

User Interface

Dual 4-digit LED Displays
Keypad : 4 keys
Programming Port : For automatic setup, calibration and testing
Communication Port : RS-232 and RS-485

Control Mode

Output 1 : Reverse (heating) or direct (cooling) action
Output 2 : PID cooling control, cooling P band 50~300%
of PB, dead band -36.0 ~ 36.0 % of PB
ON-OFF : 0.1 - 90.0 (°F) hysteresis control (P band = 0)
P or PD : 0 - 100.0 % offset adjustment
PID : Fuzzy logic modified
Proportional band 0.1 ~ 900.0 °F.
Integral time 0 - 1000 seconds
Derivative time 0 - 360.0 seconds
Cycle Time : 0.1 - 90.0 seconds
Manual Control : Heat (MV1) and Cool (MV2)
Auto-tuning : Cold start and warm start
Failure Mode : Auto-transfer to manual mode while
sensor break or A-D converter damage
Ramping Control : 0 - 900.0 °F/minute or
0 - 900.0 °F/hour ramp rate

Digital Filter

Function : First order
Time Constant : 0, 0.2, 0.5, 1, 2, 5, 10, 20, 30, 60
seconds programmable

Profiler

Number of profiles :	9
Number of Segment per profile	
Profile 1, 2, 3, 4 :	16
Profile 5, 6, 7 :	32
Profile 8, 9 :	64
Event Outputs :	3

Environmental & Physical

Operating Temperature :	-10 °C to 50 °C
Storage Temperature :	-40 °C to 60 °C
Humidity :	0 to 90 % RH (non-condensing)
Altitude:	2000m maximum
Pollution:	Degree 2
Insulation Resistance :	20 Mohms min. (at 500 VDC)
Dielectric Strength :	2000 VAC, 50/60 Hz for 1 minute
Vibration Resistance :	10 - 55 Hz, 10 m/s ² for 2 hours
Shock Resistance :	200 m/s ² (20 g)
Moldings :	Flame retardant polycarbonate
Dimensions :	
P41 -----	96mm(W) X 96mm(H) X 65mm(D), 53 mm depth behind panel
P91 -----	48mm(W) X 48mm(H) X 116mm(D), 105 mm depth behind panel
Weight : P41 -----	250 grams
P91 -----	150 grams
Overvoltage Category:	II
Power Input Voltage fluctuations:	±10 % of the nominal voltage

Approval Standards

Safety :	UUL 61010-1, 3rd Edition. CAN/CSA-C22.2 No. 61010-1(2012-05), 3rd Edition.
----------	---

Protective Class :

IP65 for panel with additional option
IP50 for panel without additional option
IP20 for terminals and housing with protective cover.
All indoor use.

EMC:	EN61326
------	---------

Chapter 7 Modbus Communications

This chapter specifies the Modbus Communications protocol as RS-232 or RS-485 interface module is installed. Only RTU mode is supported. Data is transmitted as eight-bit binary bytes with 1 start bit, 1 stop bit and optional parity checking (None, Even or Odd). Baud rate may be set to 2400, 4800, 9600, 14400, 19200, 28800 and 38400.

7-1 Functions Supported

Only function 03, 06 and 16 are available for this series of controllers. The message formats for each function are described as follows:

Function 03: Read Holding Registers

Query (from master)	Response (from slave)
Slave address (1-247)	←
Function code (3)	←
Starting address of register Hi (0)	Byte count
Starting address of register Lo (0-117, 128-143)	Data 1 Hi
	Data 1 Lo
No. of words Hi (0)	Data 2 Hi
No. of words Lo (1-118)	Data 2 Lo
CRC16 Hi	⋮
CRC16 Lo	⋮
	CRC16 Hi
	CRC16 Lo

Function 06: Preset single Register

Query (from master)	Response (from slave)
Slave address (1-247)	←
Function code (6)	←
Register address Hi (0)	←
Register address Lo (0-117, 128-143)	←
Data Hi	←
Data Lo	←
CRC16 Hi	←
CRC16 Lo	←

Function 16: Preset Multiple Registers

Query (from master)	Response (from slave)
Slave address (1-247)	←
Function code (16)	←
Starting address of register Hi (0)	←
Starting address of register Lo (0-117, 128-143)	←
No. of words Hi (0)	←
No. of words Lo (1-118)	←
Byte count (2-236)	CRC16 Hi
Data 1 Hi	CRC16 Lo
Data 1 Lo	
Data 2 Hi	
Data 2 Lo	
•	
•	
•	
CRC16 Hi	
CRC16 Lo	

7-2 Exception Responses

If the controller receives a message which contains a corrupted character (parity check error, framing error etc.), or if the CRC16 check fails, the controller ignores the message.

However, if the controller receives a syntactically correct message which contains an illegal value, it will send an exception response, consisting of five bytes as follows:

slave address + offset function code + exception code + CRC16 Hi + CRC16 Lo

Where the offset function code is obtained by adding the function code with 128 (ie. function 3 becomes H'83), and the exception code is equal to the value contained in the following table:

Exception Code	Name	Cause
1	Bad function code	Function code is not supported by the controller
2	Illegal data address	Register address out of range
3	Illegal data value	Data value out of range or attempt to write a read-only or protected data

Table 7.1 Exception Code Table

7-3 Parameter Table

You can refer to **section 1-6** for the parameter description. The register address for each parameter is shown in the first column of the table. The register 133 for EROR is the error code. The error code description is shown in Table A.1.

The register 140 for PROG is the program code of the product. The program code is 37.xx for P41 and 38.xx for P91 where xx denotes the software version number. For example, PROG = 37.12 means that the profiler is P41 with software version 12.

7-4 Number System

The values stored in registers are based on 2's complement format.

The relation between the value of number in register and its actual value is shown as following table.

Number in register	Actual value
65535	-1
65534	-2
50000	-15536
32769	-32767
32768	-32768
32767	32767
10000	10000
3	3
2	2
1	1
0	0

Table 7.2 Number Conversion Table

7-5 Communication Example

Example 1: Read the real time data (register 128~141)

Query

	03	00	0x80	00	0x0E	Hi	Lo
Addr.	Func.	Starting Addr.		No. of words		CRC16	

Example 2: Read segment 2 data of profile 3

Query

	06	00	0x56	00	03	Hi	Lo
Addr.	Func.	Starting Addr.		Data Hi / Lo		CRC16	

Query

	06	00	0x5B	00	02	Hi	Lo
Addr.	Func.	Register Addr.		Data Hi / Lo		CRC16	

Query

	03	00	0x5C	00	09	Hi	Lo
Addr.	Func.	Starting Addr.		No. of words		CRC16	

Example 3 : Perform reset function

Query

	06	00	0x8E	0x68	0x25	Hi	Lo
Addr.	Func.	Register Addr.		Data Hi / Lo		CRC16	

Example 4 : Enter auto-tuning mode

Query

	06	00	0x0B	00	03	Hi	Lo
Addr.	Func.	Register Addr.		Data Hi / Lo		CRC16	

Example 5 : Enter manual mode

Query

	06	00	0x0B	00	05	Hi	Lo
Addr.	Func.	Register Addr.		Data Hi / Lo		CRC16	

Example 6 : Modify the Calibration coefficient

Preset the CMND register with 26668 before attempting to change the calibration coefficient.

Query

	06	00	0x8E	0x68	0x29	Hi	Lo
Addr.	Func.	Register Addr.		Data Hi / Lo		CRC16	

Example 7 : Start from segment 4 to run profile 3

Query

	06	00	0x0B	00	00	Hi	Lo
Addr.	Func.	Register Addr.		Data Hi / Lo		CRC16	

Query

	06	00	01	01	0x30	Hi	Lo
Addr.	Func.	Register Addr.		Data Hi / Lo		CRC16	

Example 8 : Hold the current profile

Query

	06	00	0x0B	00	01	Hi	Lo
Addr.	Func.	Register Addr.		Data Hi / Lo		CRC16	

Example 9 : Create the profile which is specified in example of Fig. 4.7

Query

	0x10	00	0x50	00	05	0x0A	00	02	00	02
Addr.	Func.	Starting Addr.	No. of words		Bytes	STAR = 2		END = 2		

00	00	00	01	00	0x64	Hi	Lo
DLAY = 0		PFR = 1		HBT = 1.00		CRC16	

Query

	0x10	00	0x56	00	05	0x0A	00	01
Addr.	Func.	Starting Addr.	No. of words		Bytes	PROF = 1		

00	0x32	00	0xFA	00	00	00	00	Hi	Lo
HBBB = 5.0		STSP = 25.0		RMPU = 0		DLLU = 0		CRC16	

Query

	0x10	00	0x5B	00	06	0x0C	00	00	00	00		
Addr.	Func.	Starting Addr.		No. of words		Bytes	SGNO = 0		SGTY = 0			
0x05	0xDC	00	0x0F	00	00	00	01	Hi	Lo			
TGSP = 150.0		RTRR = 15		P2EV = 0		HBTY = 1		CRC16				

Query

	0x10	00	0x5B	00	02	04	00	01	00	01	Hi	Lo
Addr.	Func.	Starting Addr.		No. of words		Bytes	SGNO=1		SGTY=1		CRC16	

Query

	0x10	00	0x5F	00	03	06	00	00	00	03	00	0x14	Hi	Lo
Addr.	Func.	Starting Addr.		No. of words		Bytes	P2EV=0		HBTY=3		DLLT=20		CRC16	

Query

	0x10	00	0x5B	00	06	0x0C	00	02	00	00		
Addr.	Func.	Starting Addr.		No. of words		Bytes	SGNO = 2		SGTY = 0			
0x09	0xC4	00	0x14	00	00	00	01	Hi	Lo			
TGSP = 250.0		RTRR = 20		P2EV = 0		HBTY = 1		CRC16				

Query

	0x10	00	0x5B	00	02	04	00	03	00	01	Hi	Lo
Addr.	Func.	Starting Addr.		No. of words		Bytes	SGNO=3		SGTY=1		CRC16	

Query

	0x10	00	0x5F	00	03	06	00	00	00	03	00	0x0A	Hi	Lo
Addr.	Func.	Starting Addr.		No. of words		Bytes	P2EV=0		HBTY=3		DLLT=10		CRC16	

Query

	0x10	00	0x5B	00	06	0x0C	00	04	00	00		
Addr.	Func.	Starting Addr.		No. of words		Bytes	SGNO = 4		SGTY = 0			
0x05	0xDC	00	0x19	00	01	00	02	Hi	Lo			
TGSP = 150.0		RTRR = 25		P2EV = 1		HBTY = 2		CRC16				

Query

	0x10	00	0x5B	00	02	04	00	05	00	02	Hi	Lo
Addr.	Func.	Starting Addr.		No. of words		Bytes	SGNO=5		SGTY=2		CRC16	

Query

	0x10	00	0x62	00	02	04	00	01	00	02	Hi	Lo
Addr.	Func.	Starting Addr.		No. of words		Bytes	SEG=2		CYCL=2		CRC16	

Query

	0x10	00	0x5B	00	02	04	00	06	00	01	Hi	Lo
Addr.	Func.	Starting Addr.		No. of words		Bytes	SGNO=6		SGTY=1		CRC16	

Query

	0x10	00	0x5F	00	03	06	00	00	00	03	00	0x18	Hi	Lo
Addr.	Func.	Starting Addr.		No. of words		Bytes	P2EV=0		HBTY=3		DLLT=24		CRC16	

Query

	0x10	00	0x5B	00	06	0x0C	00	07	00	00	0x19	0x64
Addr.	Func.	Starting Addr.		No. of words		Bytes	SGNO=7		SGTY=0		TGSP=650.0	
00	0x1E	00	0A	00	01	Hi	Lo					
RTRR=30		P2EV=10		HBTY = 1		CRC16						

Query

	0x10	00	0x5B	00	02	04	00	08	00	01	Hi	Lo
Addr.	Func.	Starting Addr.		No. of words		Bytes	SGNO=8		SGTY=1		CRC16	

Query

	0x10	00	0x5F	00	03	06	00	0x0A	00	03	00	0x1E	Hi	Lo
Addr.	Func.	Starting Addr.		No. of words		Bytes	P2EV=10		HBTY=3		DLLT=30		CRC16	

Query

	0x10	00	0x5B	00	06	0x0C	00	0x09	00	00	0x11	0x94		
Addr.	Func.	Starting Addr.		No. of words		Bytes	SGNO=9		SGTY=0		TGSP=450.0			

00	0x1E	00	0x0B	00	02	Hi	Lo
RTRR=30		P2EV=11		HBTY = 2		CRC16	

Query

	0x10	00	0x5B	00	02	04	00	0x0A	00	01	Hi	Lo
Addr.	Func.	Starting Addr.		No. of words		Bytes	SGNO=10		SGTY=1		CRC16	

Query

	0x10	00	0x5F	00	03	06	00	0x0A	00	03	00	0x14	Hi	Lo
Addr.	Func.	Starting Addr.		No. of words		Bytes	P2EV=10		HBTY=3		DLLT=20		CRC16	

Query

	0x10	00	0x5B	00	06	0x0C	00	0x0B	00	00		
Addr.	Func.	Starting Addr.		No. of words		Bytes	SGNO =11		SGTY = 0			

0x03	0xE8	00	0x0B	00	01	00	02	Hi	Lo
TGSP = 100.0		RTRR = 11		P2EV = 1		HBTY = 2		CRC16	

Query

	0x10	00	0x5B	00	02	04	00	0x0C	00	03	Hi	Lo
Addr.	Func.	Starting Addr.		No. of words		Bytes	SGNO=12		SGTY=3		CRC16	

Query

	0x10	00	0x63	00	02	04	00	02	0x03	0xE8	Hi	Lo
Addr.	Func.	Starting Addr.		No. of words		Bytes	CYCL=2		FSP=100.0		CRC16	

Chapter 8 Manual Calibration

 Do not proceed through this section unless there is a definite need to re-calibrate the controller. Otherwise, all previous calibration data will be lost. Do not attempt recalibration unless you have appropriate calibration equipment. If calibration data is lost, you will need to return the controller to your supplier who may charge you a service fee to re-calibrate the controller.

 Entering calibration mode will break the control loop. Make sure that if the system is allowable to apply calibration mode.

Equipments needed before calibration:

- (1) A high accuracy calibrator (Fluke 5520A Calibrator recommended) with following functions:
 - 0 - 100 mV millivolt source with $\pm 0.005\%$ accuracy
 - 0 - 10 V voltage source with $\pm 0.005\%$ accuracy
 - 0 - 20 mA current source with $\pm 0.005\%$ accuracy
 - 0 - 300 ohm resistant source with $\pm 0.005\%$ accuracy
- (2) A test chamber providing 25 °C - 50 °C temperature range
- (3) A switching network (SWU16K, optional for automatic calibration)
- (4) A calibration fixture equipped with programming units (optional for automatic calibration)
- (5) A PC installed with calibration software BC-Net and Smart Network Adaptor SNA10B (optional for automatic calibration)

The calibration procedures described in the following section are a step by step **manual procedures**.

Since it needs 30 minutes to warm up an unit before calibration, calibrating the unit one by one is quite inefficient. An **automatic calibration system** for small quantity as well as for unlimited quantity is available upon request.

Manual Calibration Procedures for P41 / P91

(a) For the thermocouple, RTD and 0-60mV signal inputs

Step 1. Set the Input sensor selection at K_tc, Short G1 and open G2 by soldering G1 and desoldering G2.

Step 2. Press the page key then release for 2 times until the **PrOf** appears on the display, Press the page key for least 5 seconds then release the display will show **LoF** . Press the page key for at least 5 seconds then release, the display will show **ALo** .

Step 3. Press the scroll key for at least 5 seconds then release, the display will show **AdLo** and the unit enters calibration mode. Send a 0.0 mV signal to the thermocouple input terminals. Press scroll key for at least 5 seconds. The display will blink a moment and a new value is obtained. Otherwise if the display didn't blink or if the obtained value is equal to -1999 or 1999, then the calibration fails.

Step 4. Press the scroll key then release, the display will show **AdHi** . Send a 60 mV signal to the thermocouple input terminals in correct polarity. Press scroll key for at least 5 seconds. The display will blink a moment and a new value is obtained. Otherwise if the display didn't blink or if the obtained value is equal to -1999 or 1999, then the calibration fails.

Step 5. Press the scroll key then release, the display will show **rtdL** . Send a 100 ohms signal with 3-wire to the RTD input terminals. Press scroll key for at least 5 seconds. The display will blink a moment. Otherwise if the display didn't blink, then the calibration fails.

Step 6. Press the scroll key then release, the display will show **rtdH** . Change the ohm's value to 300ohms. Press scroll key for at least 5 seconds . The display will blink a moment and two values are obtained for **rtdL** and **rtdH** .Otherwise if the display didn't blink or if any value obtained for **rtdL** and **rtdH** is equal to -1999 or 1999, then the calibration fails.

- Step 7. Connect a K type thermocouple to the thermocouple input terminals. Press the scroll key then release, the display will show $\boxed{\text{C J L O}}$. Apply up/down key until value 0.00 is obtained. The unit under calibration is powered in a still-air room with temperature 25 ± 3 °C. Stay at least 20 minutes for warming up. Send a 0.0 °C signal to the thermocouple input terminals. Apply up/down key until 0.00 is obtained. Press scroll key for at least 5 seconds. The display will blink a moment and a new value is obtained. Otherwise if the display didn't blink or if the obtained value is equal to -5.00 or 40.00, then the calibration fails.
- Step 8. Return to the static mode by pressing up and down key at a time then release.

(b). For a linear current input

- Step 9. Set the Input sensor selection at 0-20mA, Short G2 by soldering G2.
- Step 10. Perform step 2 .
- Step 11. Press the scroll key for at least 5 seconds then release, the display will show $\boxed{\text{R d L O}}$.
- Step 12. Perform step 4 but send a span signal 20mA to the input terminals instead of 60mV.
- Step 13. Perform step 8.

(c). For a linear voltage input

- Step 14. Set the Input sensor selection at 0-10V, open G1 and G2 by desoldering both G1 and G2.
- Step 15. Perform step 2 .
- Step 16. Press the scroll key for at least 5 seconds then release, the display will show $\boxed{\text{R d L O}}$.
- Step 17. Perform step 4 but send a span signal 10V to the input terminals instead of 60mV.
- Step 18. Perform step 8.

Appendix A-1

Table A.1 Error Codes and Corrective Actions

Error Code	Display Symbol	Error Description	Corrective Action
4	<i>Er 04</i>	Illegal setup values been used: Before COOL is used for OUT2, DIRT (cooling action) has already been used for OUT1, or PID mode is not used for OUT1 (that is PB = 0, and / or TI = 0)	Check and correct setup values of OUT2, PB, TI and OUT1. IF OUT2 is required for cooling control, the control should use PID mode (PB ≠ 0, TI ≠ 0) and OUT1 should use reverse mode (heating action) , otherwise, don't use OUT2 for cooling control.
10	<i>Er 10</i>	Communication error: bad function code	Correct the communication software to meet the protocol requirements.
11	<i>Er 11</i>	Communication error: register address out of range	Don't issue an over-range register address to the slave.
14	<i>Er 14</i>	Communication error: attempt to write a read-only data or a protected data	Don't write a read-only data or a protected data to the slave.
15	<i>Er 15</i>	Communication error: write a value which is out of range to a register	Don't write an over-range data to the slave register.
25	<i>HbEr</i>	Holdback time out	Evaluate validity of the PID values
26	<i>AtEr</i>	Fail to perform auto-tuning function	<ol style="list-style-type: none"> 1.The PID values obtained after auto-tuning procedure are out of range. Retry auto-tuning. 2.Don't change set point value during auto-tuning procedure. 3.Use manual tuning instead of auto-tuning. 4. Don't set a zero value for PB. 5. Don't set a zero value for TI. 6. Touch RESET key
27	<i>CAEr</i>	You have selected an input type which was not calibrated	Calibrate the new input type or change input type to the calibrated one.
29	<i>EEPE</i>	EEPROM can't be written correctly	Return to factory for repair.
30	<i>CJEr</i>	Cold junction compensation for thermocouple malfunction	Return to factory for repair.
39	<i>SbEr</i>	Input sensor break, or input current below 1 mA if 4-20 mA is selected, or input voltage below 0.25V if 1 - 5V is selected	Replace input sensor.
40	<i>AdEr</i>	A to D converter or related component(s) malfunction	Return to factory for repair.

Appendix A-2

WARRANTY

Brainchild Electronic Co., Ltd. is pleased to offer suggestions on the use of its various products. However, Brainchild makes no warranties or representations of any sort regarding the fitness for use, or the application of its products by the Purchaser. The selection, application or use of Brainchild products is the Purchaser's responsibility. No claims will be allowed for any damages or losses, whether direct, indirect, incidental, special or consequential. Specifications are subject to change without notice. In addition, Brainchild reserves the right to make changes without notification to Purchaser to materials or processing that do not affect compliance with any applicable specification. Brainchild products are warranted to be free from defects in material and workmanship for 18 months after delivery to the first purchaser for use. An extended period is available with extra cost upon request. Brainchild's sole responsibility under this warranty, at Brainchild's option, is limited to replacement or repair, free of charge, or refund of purchase price within the warranty period specified. This warranty does not apply to damage resulting from transportation, alteration, misuse or abuse.

RETURNS

No products return can be accepted without a completed Return Material Authorization (RMA) form.



- Please install 20A circuit breaker on the power supply end
 - To remove the dust please use the dry cloth
 - The installation that the safety of any system incorporating the equipment is the responsibility of the assembler of the system
 - If the equipment is used in a manner not specified by the manufacturer, the protection provided by the equipment may be impaired
 - Do not cover the cooling vents to maintain airflow
 - Beware not to over-tighten the terminal screws. The torque should not exceed 1N-m (8.9 Lb-in or 10.2 Kgf-cm), temperature Min. 60°C, use copper conductors only.
-
- Veuillez installer un disjoncteur 20A à l'extrémité de l'alimentation
 - Pour enlever la poussière, veuillez utiliser le chiffon sec
 - L'installation que la sécurité de tout système incorporant l'équipement est la responsabilité de l'assembleur du système
 - Si l'équipement est utilisé d'une manière non spécifiée par le fabricant, la protection fournie par l'équipement peut être altérée
 - Ne couvrez pas les événements de refroidissement pour maintenir le flux d'air
 - Attention, veuillez ne pas trop serrer les vis des bornes. Le couple ne doit pas dépasser 1 N-m (8,9 Lb-in ou 10,2 Kgf-cm). La température minimale est de 60°C. Utilisez uniquement des conducteurs en cuivre.

For any repair or maintenance needs, please contact us.

BrainChild Electronic Co., Ltd.

No.209, Chung Yang Rd., Nan Kang Dist.,

Taipei, Taiwan, 11573

Tel: 886-2-27861299

Fax: 886-2-27861395

web site: <http://www.brainchildtw.com>