

BrainChild

XHLogger Series XH13

Data Logger User Manual

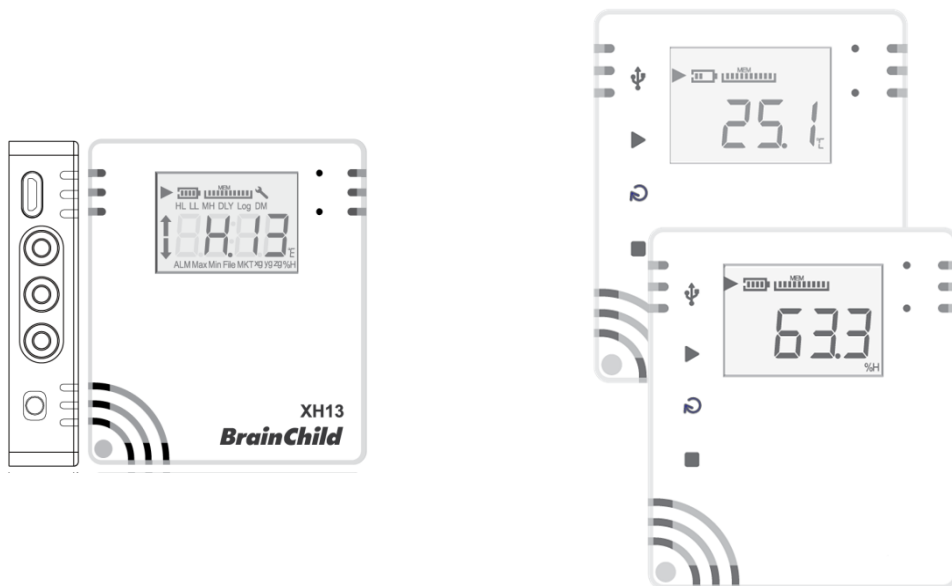

*UMEXH131E EN v0.61 (Mar 2025)
XH logger Firmware Version: 1.5.0
Data Logger Viewer Version: 1.3.0.26
XH13 Cloud Web Version: 2024.07
XH Logger App Version: 2.0.18 (50)*

Terms & Policy

The documentation, hardware, accessories and software included with this product are copyrighted by Brainchild Electronic Co. Ltd. All rights are reserved. Users should read this document, the stated terms and usage policies through. You agree to be bound by these Terms of Use and all terms incorporated by reference.

Safety

Users should read this document through before use it and refer to it whenever necessary. Pay attention to the safety instructions and warning notices to prevent from injuries or damaging to the equipment.

Follow the instructions and specification limit to operate it to avoid any dangers.

Copyright

Copyright a 2024, The Brainchild Electronic Co., Ltd., all rights reserved. No part of this publication may be reproduced, transmitted, transcribed or stored in a retrieval system, or translated into any language in any form by any means without the written permission of the Brainchild Electronic Co., Ltd.

Warning Symbol

The Symbol calls attention to an operating procedure, practice, or the like, which, if not correctly performed or adhered to, could result in personal injury or damage to or destruction of part or all of the product and system. Do not proceed beyond a warning symbol until the indicated conditions are fully understood and met.

Disposal

Users are responsible for the proper disposal of the waste generated during their work. Improper waste disposal may severely endanger the public health and/or the environment. Dispose the battery in accordance with local regulations.

Precaution for Humidity and Temperature Sensors

Storage and Handling Instructions:

- Protection against ESD is mandatory.
- Do not use polyethylene antistatic bags.
- Do not apply board wash.
- Do not apply spray to unprotected sensor.
- Be careful exposing the sensor to VOC.
- Prevent sensor from exposure to cleaning agents.
- Cover the sensing element during coating.

Contact Information

Head Office & Factory

Brainchild Electronic Co. Ltd.

209 Chongyang Road, Nangang Dist., Taipei 11573, Taiwan

Tel: +886-2-2786-1299

Fax: +886-2-2786-1395

Website: www.brainchildtw.com;

Email: sales@brainchild.com.tw; service@brainchild.com.tw

Revision History

Version	Description	Date
UMXH131E V0.6 (E) Ref: UMXH101E, UMXH121E	Added XH13 to initial release V0.59(E) Revised FAQ, Battery replacement, Key definition, key operation, LED definition V0.6 (E): Spec-- log interval, memory; product-name del, configuration, sec7, 1.4, 1.5, 1.6, 2.1, 2.3.8, FAQ	2025/ Jan
V0.61 (E)	1.3.1 Logging interval	2025/ Mar/21
v1.0.0 (E) EN	Initial release	TBA

Table of Contents

1	Introduction	- 7 -
1.1	Features	- 8 -
	XH13 Features:.....	- 8 -
1.2	Package	- 10 -
1.3	XHLogger Specifications	- 11 -
1.3.1	XH13 Specifications	- 11 -
1.4	Product Overview	- 13 -
1.5	Appearance and Dimension.....	- 14 -
1.6	Ordering Code.....	- 14 -
1.7	LCD Display	- 15 -
1.8	Scrolling Sequence	- 18 -
1.9	LCD MEM Display.....	- 20 -
1.10	Memory Management	- 20 -
1.11	Installation of Mounting Plate.....	- 21 -
2	XH13 Wireless Pairing & Configuration.....	- 22 -
2.1	XH Logger App Pairing with XH13	- 22 -
2.2	XH13 App Activation.....	- 25 -
2.2.1	APP Registration & Activation.....	- 25 -
2.2.2	Firmware Update via XH13 App	- 28 -
2.3	XH13 Cloud Web Pairing	- 29 -
2.3.1	Cloud Web Registration & Activation	- 29 -
2.3.2	Cloud Web Registration & Activation	- 35 -
3	Operation Mode and Keypads	- 37 -
3.1	XH13 Operation.....	- 37 -
3.1.1	XH13 Operation of Keypads	- 37 -
3.1.2	XH13 Operation Mode	- 37 -
3.2	Operaion Modes.....	- 38 -
3.3	Reboot Button	- 40 -
4	LED Display	- 41 -

4.1 LED Signal Lights..... - 41 -

5 Error Code - 42 -

5.1 XH13 Error Code..... - 42 -

6 Battery..... - 44 -

6.1 XH13 Battery - 44 -

6.1.1 XH13 Power Supply..... - 44 -

6.1.2 XH13 Battery Replacement - 44 -

6.1.3 XH13 Battery Charge..... - 45 -

6.2 XHLogger Battery Level and Percentage..... - 46 -

7 Product FAQ - 47 -

8 Announcements - 51 -

1 Introduction

Thank you for choosing the XHLogger for your data logging needs. Data Logger XH series is an ideal solution for measuring and logging the temperature and humidity of an environment at the specified intervals. The logger not only provides temperature and humidity measurement on user's demand but also has several different recording methods, analysis data and report output function, No programming skills are required to use the UI of XH series and users can easily initiate data collection.

All data can be captured and stored in an easy-to-read format. Our goal is to bring you to an accurate, low-cost, easy-to-use data logger that can be easily integrated into your work environment. In order to better understand your needs and provide you with better service. We welcome and appreciate your feedback.

- **CLOUD XH13 :**



The XH13 Cloud-based wireless data logger, equipped with an external sensor for tracking temperature and humidity, is specially designed to collect wirelessly data wireless over remote distance from multiple locations using App, and cloud XH13 webpage, configuration, monitoring, setting parameter and exporting reports via Cloud, suitable for users hoping to have instant access to relevant information through a dedicated account whether at home, office or on the trip, from multi-location remote control. Applications for the industries include but not limited to: electronic component warehouse, vaccine preservation, intelligence warehousing, food factory, biotechnology, medical equipment, etc, where you can control and monitor your business environmental changes and data-based quality assurance.

1.1 Features

The XHLogger series has the following unique features:

- ❖ One click start/stop, pre-set start/stop
- ❖ USB interface
- ❖ Logging of temperature & humidity statistics
- ❖ MKT temperature logging
- ❖ Offer Celsius & Fahrenheit temperature measurement
- ❖ LCD display, real-time temperature & device status shown
- ❖ Temperature and humidity audit trail
- ❖ User configurable sampling interval
- ❖ Records Mean Kinetic Temperature (MKT) tracking
- ❖ Dual-mode power supply, USB/ Battery-powered
- ❖ Direct export PDF reports
- ❖ Use the interface to start collecting data immediately without any programming skills
- ❖ Waterproof and dustproof housing

◆ XH13 Features:

- ❖ Cloud Data Logger, wireless XHLogger
- ❖ Temperature & humidity logging and statistic
- ❖ External sensor for both temperature and humidity
- ❖ Wi-Fi Communication
- ❖ Works great with both Android and iOS mobile devices
- ❖ Auto data resume
- ❖ Wireless configuration, monitoring; set parameters & download report via Cloud
- ❖ Remote start/stop scheduling via cloud
- ❖ USB-powered/ USB battery charging
- ❖ 1500mAh rechargeable battery power supply
- ❖ IP 63 rated housing



MKT Temperature

Mean kinetic temperature (MKT) is a simplified way of expressing the overall effect of temperature fluctuations during storage or transit of perishable goods. The MKT is widely used in the pharmaceutical industry.

The mean kinetic temperature can be expressed as:

$$T_K = \left(\frac{\frac{\Delta H}{R}}{-\ln \left(\frac{t_1 e^{\frac{-\Delta H}{RT_1}} + t_2 e^{\frac{-\Delta H}{RT_2}} + \dots + t_n e^{\frac{-\Delta H}{RT_n}}}{t_1 + t_2 + \dots + t_n} \right)} \right)$$

T_K =Mean Kinetic Temperature,

ΔH =Activation Energy (in kJ mol^{-1})

R =Gas Constant (in $\text{J mol}^{-1} \text{K}^{-1}$)

T_1, T_2, T_n =Temperature at each of the sample points

t_1, t_2, t_n =time intervals at each of the sample points

When the temperature readings are taken at the same interval (i.e., $t_1, t_2 \dots t_n$), the above equation is reduced to:

$$T_K = \left(\frac{\frac{\Delta H}{R}}{-\ln \left(\frac{e^{\frac{-\Delta H}{RT_1}} + e^{\frac{-\Delta H}{RT_2}} + \dots + e^{\frac{-\Delta H}{RT_n}}}{n} \right)} \right)$$

Where,

n = Number of temperature sample points.

1.2 Package

Upon receipt of the shipment, remove the data logger from the carton and inspect the unit for shipping damage. If any damage is found, contact your local representative immediately. Note the model number and serial number for future reference when corresponding with our service center. The serial number (S/N) is labelled on the box and the housing of the data logger.

The package contents are as below.

XH13

- ❖ Cloud Data Logger x 1 (battery already installed in the data logger)
 - 3.7V/ 1500mA Li-ion
(Rechargeable Li Battery)
- ❖ Mounting Plate and Fixed Sticker x 1
- ❖ Screws and Anchors x 2
- ❖ External Sensor Probe x1 (Sensor length 1 or 2 M)
- ❖ Quick User Guide x 1

1.3 XHLogger Specifications

1.3.1 XH13 Specifications

XH13 Cloud Data Logger

Items	Spec Description		
Power Supply	Dual-mode: USB powered / Rechargeable Li-ion battery USB/ Battery: 1-year life @10 min. interval		
Interface	micro USB (power/ charging)		
Communication Protocol	Wi-Fi 2.4G/ HTTP/ AWS MQTT		
Software	Mobile App: XH Logger , iOS and Android system Cloud: AWSIOT Webpage online , working with Windows 10 and the above		
USB Voltage (@500mA)	Minimum 4.5 VDC	Typical 5 VDC	Maximum 5.5 VDC
Sensor Type	External sensor probe for temperature and humidity		
Sensor Response Time	Temperature > 2 sec Humidity: 8 sec		
Logging Interval	User configurable from 10 minutes to 24 hours		
Resolution	Temperature display resolution: 0.1 °C/ 0.1°F/ 0.1%		
Operating Range	Temperature range: -10°C (14°F) ~60°C (122°F) Humidity range: 10% RH~90%RH		
LCD Operating Range	Temperature range: -20°C (-4°F) ~60°C (122°F)		
Accuracy	Temperature: 0°C ~ 50°C (±0.3°C), Others ±0.5°C Humidity: 20%~80%@25°C(±3%RH), Others ±5%RH		
Time Accuracy	NTP (Network Time Protocol)		
Alarm Configuration	High High, High, Low, Low Low		
Calibration	Calibration is completed by the original manufacturer.		
Internal Memory	Each file can contain maximum 79,872 logs, keeping logging and overwritten		
Pre-program	User Programmable		
Start Option	Push button, Immediate, At time, Cloud controlled (App/ Webpage account)		
Auto Overwritten	Supported		
Start Delay	Supported, 1 min to 23 hr and 59 min		
Stop Option	Push button; At Time		
Default File Format	PDF		
Data Export	PDF, Excel		
Security Lock	Password Protected		
Housing	PC540 PC+ABS		

IP Rating	IP63
Dimensions, XH Case	65.1 x 70 x 23.25mm
Weight	130 g (Battery and 1M external sensor included)
XH Warranty	12 months, battery not included
Battery Type	3.7V/ 1500mA Li-ion, rechargeable Li battery
Total Charging Time	Battery charging time: when using charging power source DC5V/1A ($\geq 1A$), from 0 to 100% fully charged around 4 hours
Temperature	Temperature range during battery charging: 10°C (50°F) ~45°C (113°F)
Charging Cycle	Battery charging cycle: 2 to 3 months maximum with fully charged and normal usage
Battery Life	1 year-life @ 10 min. log interval, 1 year-life from the battery original factory 3-month lasting after battery full charged with normal usage
Battery Warranty	N/A, please contact your dealer for detail
Accuracy Certificate	Optional
Safety	CE, RoHS, FCC (Class B)

1.4 Product Overview

There are three keys: **START**, **SCROLL**, and **STOP** on the device and two LEDs on the upper right-hand corner. The top one is **RED** and **GREEN** is on the bottom. The below figures are listed the overview of the XH data logger.

XH13 Appearance

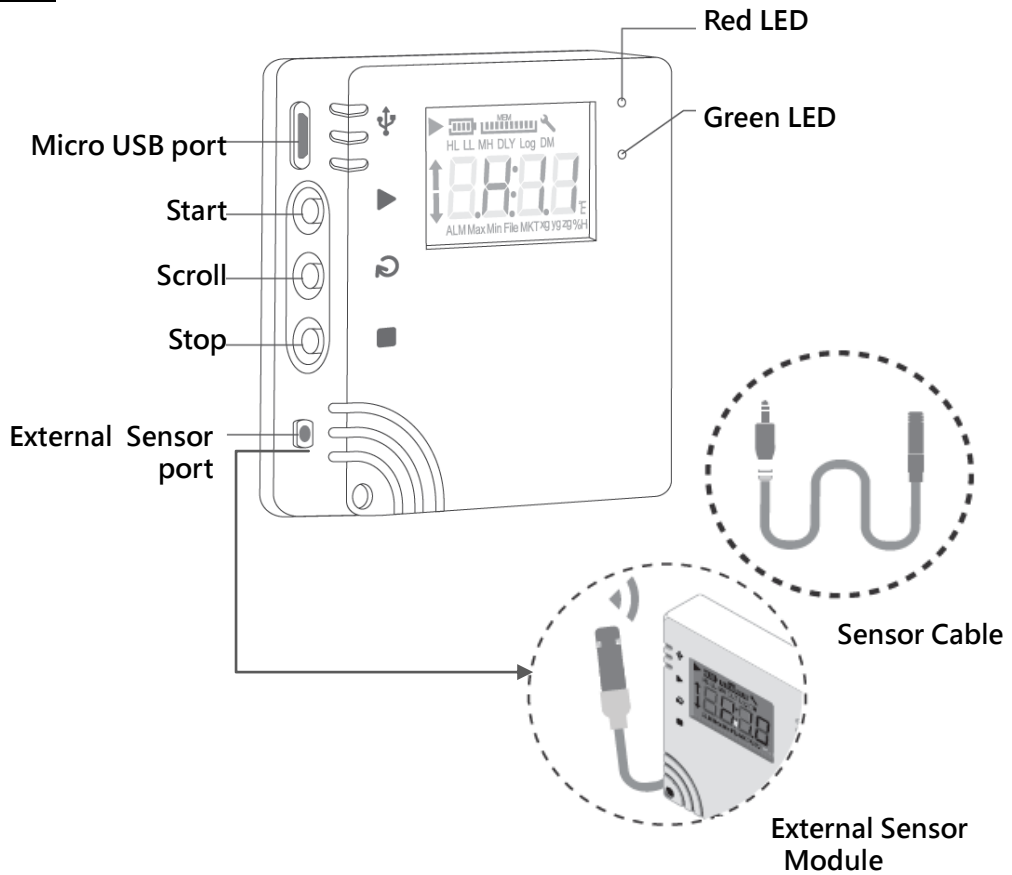

XH13 Wireless Operation with App and Webpage configuration via Cloud



1.5 Appearance and Dimension

XH13

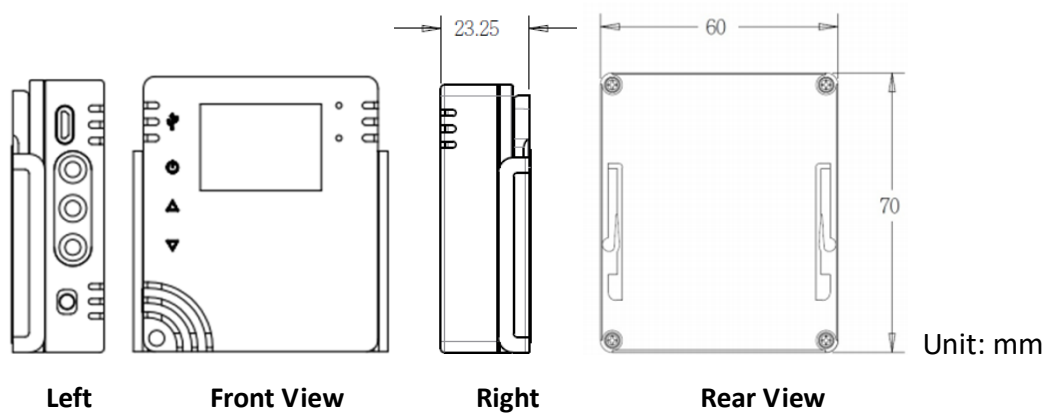

1.6 Ordering Code

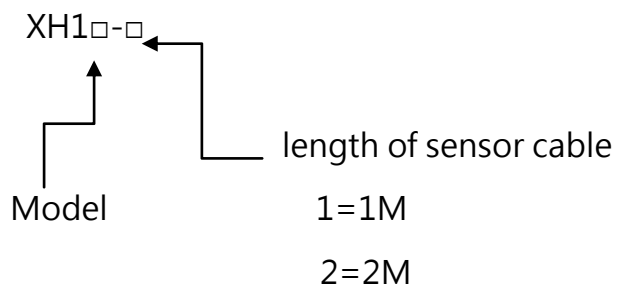



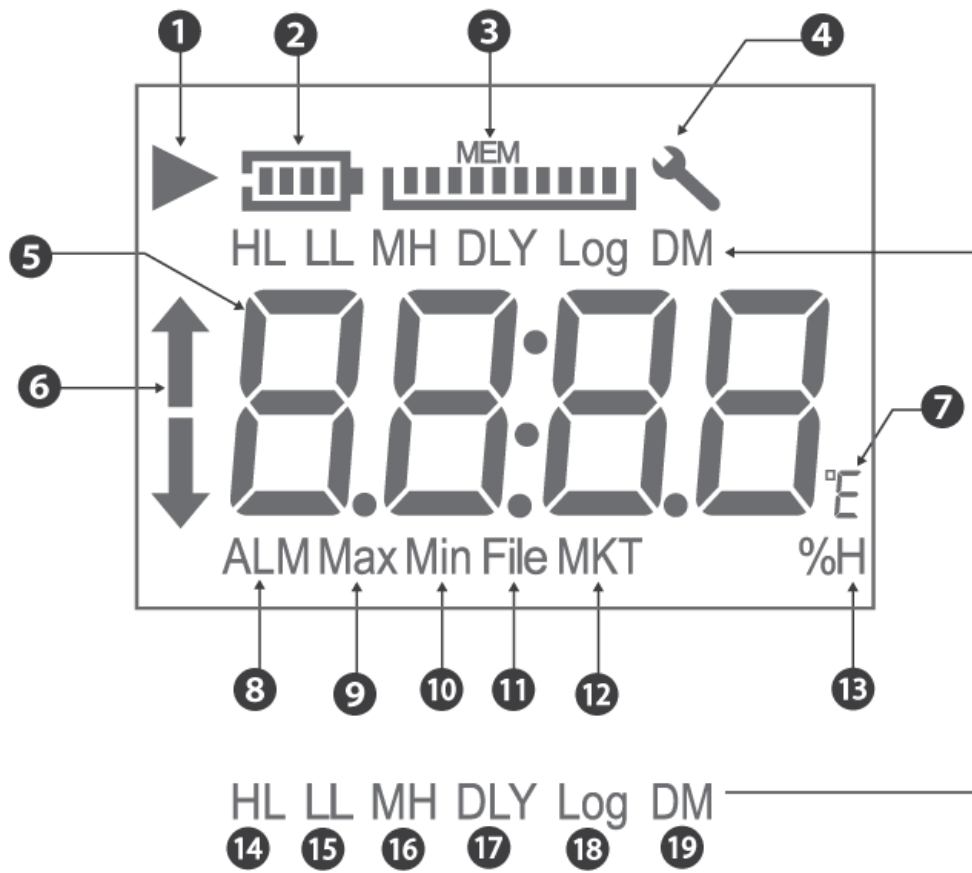

External sensor module:

- XH13-1 (Sensor length 1M)
- XH13-2 (Sensor length 2M)

1.7 LCD Display





Icon/ Symbol:

- (1) Recording icon: The symbol  indicates that the unit is recording. When the logging is complete, it disappears
Flashing icon: Flashing  indicates a delayed start or the recording function will start when the timer matches the configuration settings.
- (2) Battery icon: Battery capacity displays as a scale in proportion
- (3) MEM: Remaining memory capacity displayed in proportion
- (4) The wrench  indicates errors occurred, disappears when confirms no error occurred
- (5) Real-time temperature or humidity info
- (6) ALM bar: When temperature/humidity value reaching the alarm triggering condition,
HL  (High Limit) or LL  (Low Limit)
- (7) Temperature unit °C/ °F
- (8) ALM: When temperature/humidity value reaching the alarm triggering condition
- (9) Max: Maximum temperature or humidity value
- (10) Min: Minimum temperature or humidity value
- (11) MKT: Mean Kinetic Temperature calculation
- (12) File: Total number of files
- (13) %H: Relative Humidity %
- (14) HL: High Limit
- (15) LL: Low Limit
- (16) MH: month/ hour
- (17) DLY: Delay Time
- (18) Log: Log interval
- (19) DM: date/ minute

Abbreviations:

The LCD display is for read only operation. The display will show model number as well as firmware version for up to 2 seconds respectively after a reset operation. The XH logger firmware release version will be a three-digit formatted numerical display as "A.B.C". The below are the abbreviations of the symbols on the LCD display.

- (1) HL: High Alarm Limit set by PC software.
- (2) LL: Low Alarm Limit set by PC software.
- (3) M D: Month and Date
- (4) H M: Hour and Minutes
- (5) DLY: Delay timer before start logging, if any. Shown in H:M setup from PC.
- (6) Log: means logging interval measured in "H:M". If the logging interval is than or equal to 1 minute, then "H:M" will be shown. If the logging interval is less than 1 minute, then "H:M" won't be seen and it displays total seconds instead.
- (7) ALM: Indicate the accumulative alarm duration. It will be displayed in HH:MM (99:59) format. If the duration is more than 99:59, HH: HH will be shown instead. A user can use PC software to know further alarm duration accuracy in seconds or alarm information when HH: HH is reached.
- (8) : this means there is an alarm over HL.
- (9) : this means there is an alarm below LL.
- (10) MAX and MIN show the current logging highest and lowest values on this device; it covers both temperature and humidity.
- (11) File: specifies the file number of the current file stored in the flash memory. The total log space available in the system is 200,192 logs, which can be used for up to 100 log files. The size of each file (up to 79,872 records) depends on the user's record.
- (12) MKT is the mean kinetic temperature via an MKT formula.
- (13) %H the display unit for humidity.
- (14) °E can be set to °C or °F via PC software.

1.8 Scrolling Sequence

The LCD display will cycle thru the following value from item 1 to item 23. The user can set the scrolling display or the most used item as the “Home” display via PC software. Once the user has not touch LCD function for eight seconds, the display will jump to the “Home” display.

The parameters of items 8, 9, 12, and 23 are set by PC. The rest of the items are dynamically generated by the device.

- (1) Temperature (°C or °F)
- (2) Humidity (%RH)
- (3) Temperature & Humidity
- (4) ALM HL Temperature time (99:59, HH:MM format)
- (5) ALM LL Temperature time (99:59, HH:MM format)
- (6) ALM HL Humidity time (99:59, HH:MM format)
- (7) ALM LL Humidity time (99:59, HH:MM format)
- (8) MAX Temperature (°C or °F)
- (9) MAX Humidity (%RH)
- (10) MAXMIN Avg. Temperature (°C or °F)
- (11) MAXMIN Avg. Humidity (%RH)
- (12) MIN Temperature (°C or °F)
- (13) MIN Humidity (%RH)
- (14) File Number
- (15) MKT Temperature (°C or °F)
- (16) HL Temperature (°C or °F)
- (17) HL Humidity (%RH)
- (18) LL Temperature (°C or °F)
- (19) LL Humidity (%RH)
- (20) DLY time (Delay start recording time)
- (21) Log Time (Logging Interval) measured in H:M or seconds
- (22) M:D (Month: Date for real-time clock)
- (23) H:M (Hour: Minute for real-time clock)

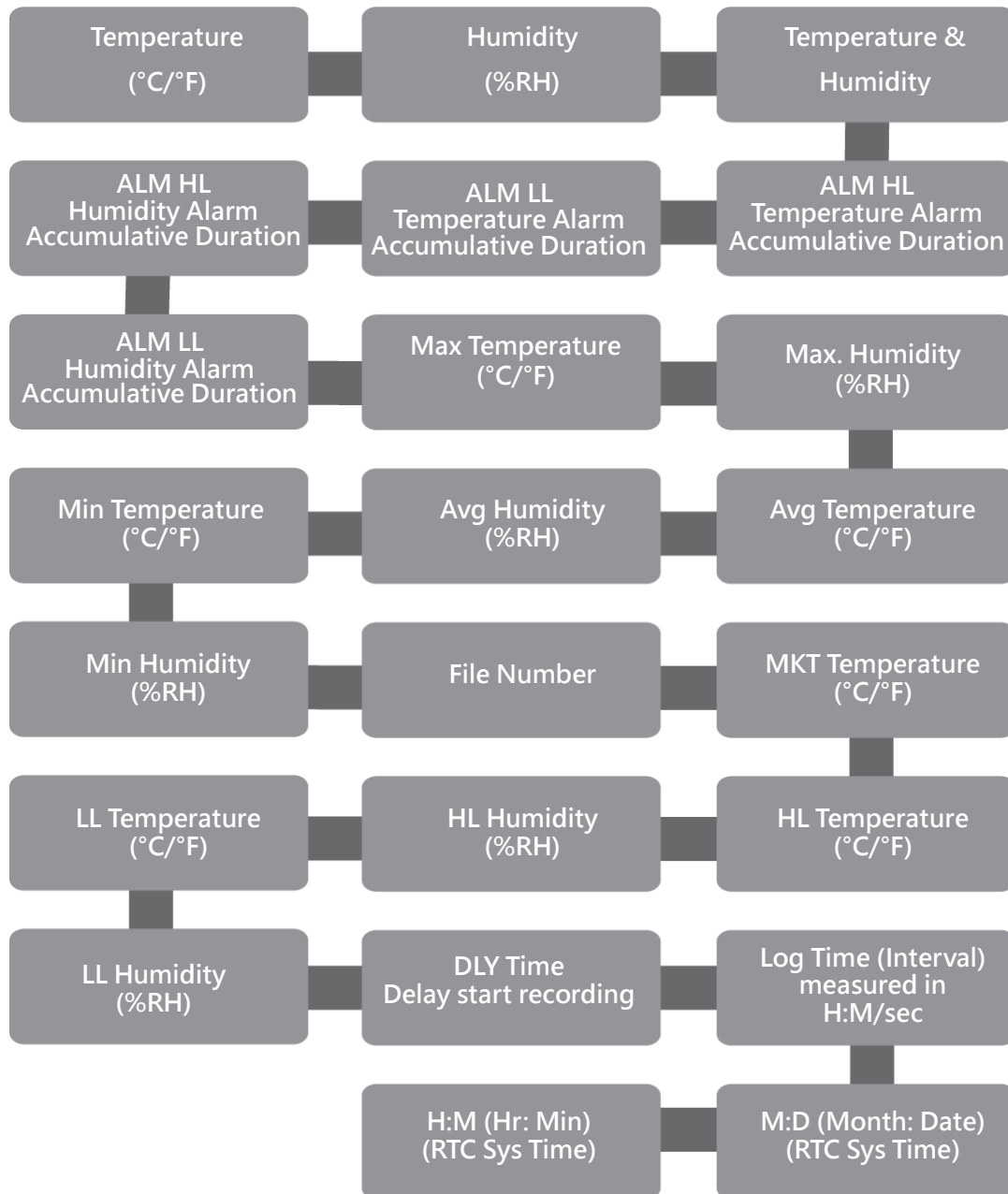

1.9 LCD MEM Display

It shows memory consuming percentage on the current file with respect to the maximum available capacity of a logging file. Each bar in the MEM icon represents 10% of the maximum capacity of a file. For example, if there are only 4 bars on the MEM display, it means the total memory consumption of the current file is approximately 60%.

1.10 Memory Management

XH13:

The size of each file (up to 79,872 records) depends on the user's record. The management of memory space for XH13 is as follows.

- ❖ File mode: single mode
- ❖ Record up to 79,872 records in a single file

The maximum capacity of a single file in the system is 79,872 records. If the capacity exceeds this limit, the old data will be automatically overwritten.

1.11 Installation of Mounting Plate

The mounting plate can be mounted by one of the below options.

- ❖ Hang it on a screw with the hanging hole
- ❖ Screw it by using the mounting screws
- ❖ Fix it with any metal base by using the magnetic base on the mounting plate
- ❖ Fix it by peeling the adhesive sticker on the mounting plate

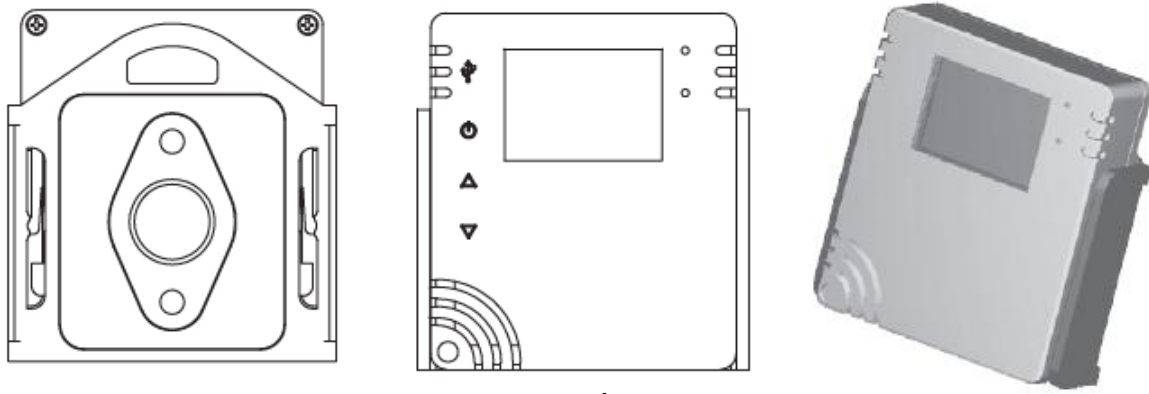
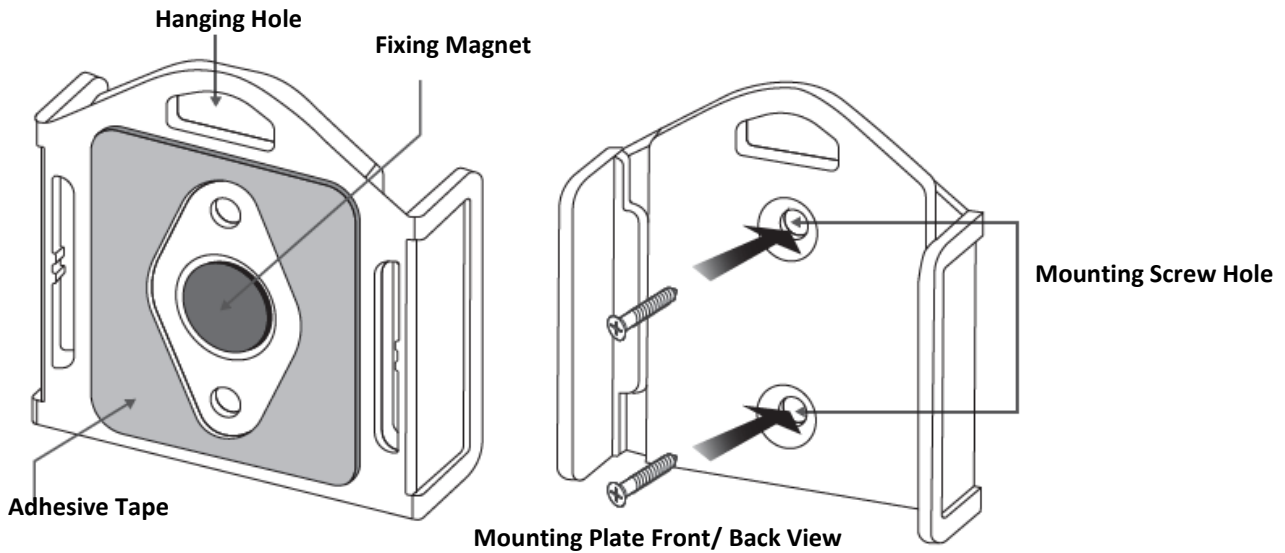

2 XH13 Wireless Pairing & Configuration

2.1 XH Logger App Pairing with XH13

Add one brand new XH13 device via XH Logger App and complete pairing XH13 with Wi-Fi, simply scanning the QR code on the back of the XH.



XH13 Pairing Video

❖ Steps for XH13 Wirelessly Pairing

- Find one XH13 powered on and running, search and download “XH Logger” from mobile App Store.

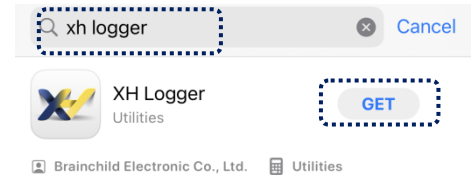

- Tap on the XH Logger APP icon on your mobile.
- Tap [Register] to complete a new account registration.
- Tap [Log in]. Fill in your email and password to login. Go to the App homepage

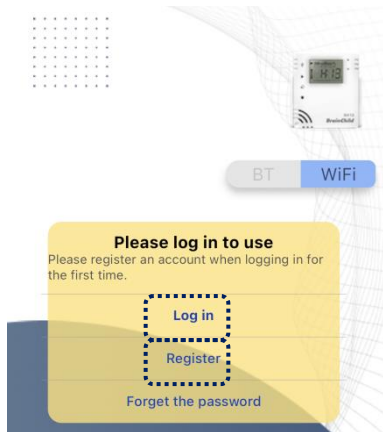

- Tap [Scan the QR Code] to add a new XH13 device.

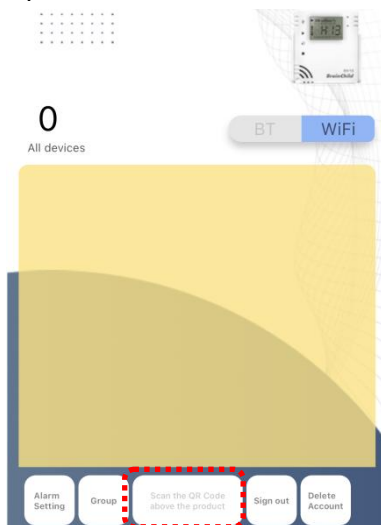

- Scan the QR Code on the back of the cover.



- Tap [Join] to add a XH13 for iOS devices and tap [Connect] for Android devices.
- Wi-Fi connection is available for pairing only when SN is shown XH13_XXXXXXX in the Wi-Fi list. If the screen [Join]/[Connect] missing, must check whether in pairing mode or not. If not, reset the device to pair again.

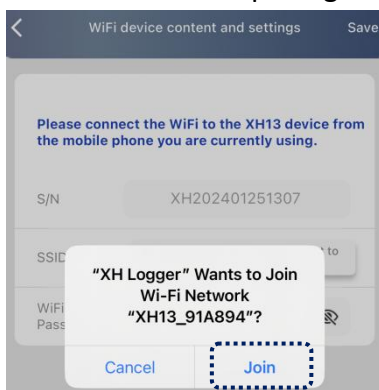

- Select one Wi-Fi name from the list to connect to the XH13. Choose one from the signal strength list. From [SSID List Signal Strength], select one Wi-Fi name and type this Wi-Fi password.



- Press [Save] in the upper right corner.

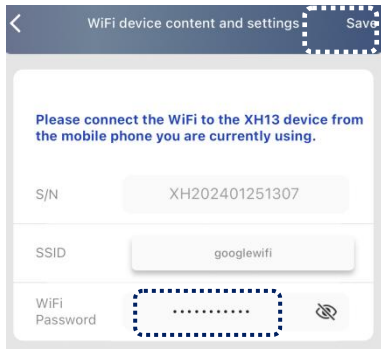

- Tap [Ok]. Device added successfully and pairing has been completed. After pairing and Wi-Fi connected, the XH13 has been shown Green online in the list.

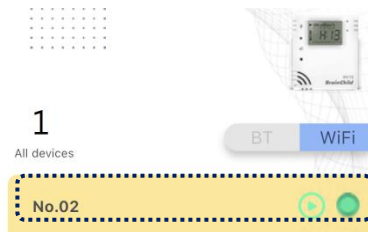
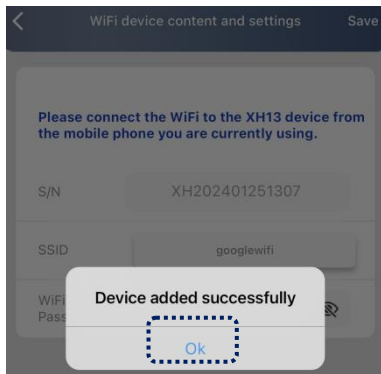

2.2 XH13 App Activation

2.2.1 APP Registration & Activation

❖ Set Time Zone

The step is required to activate the system, resetting Time to unlock the default setting.

- Select one connected XH name, which connected shown green light. Tap [•••] State in the upper right corner to enter this single device configuration. ***Reset Time and save to exit again even if your local time is the same as the default.

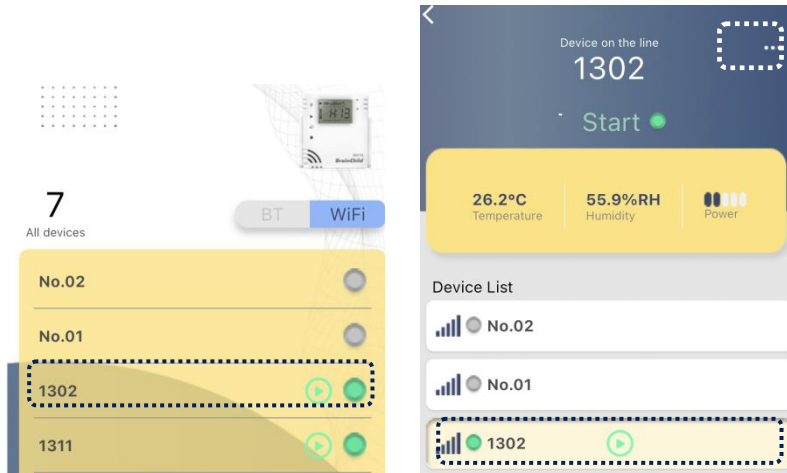

- Tap [Function Settings] > [Device Content] > [Time Zone] to select the local time zone, and then tap [Save] to exit.

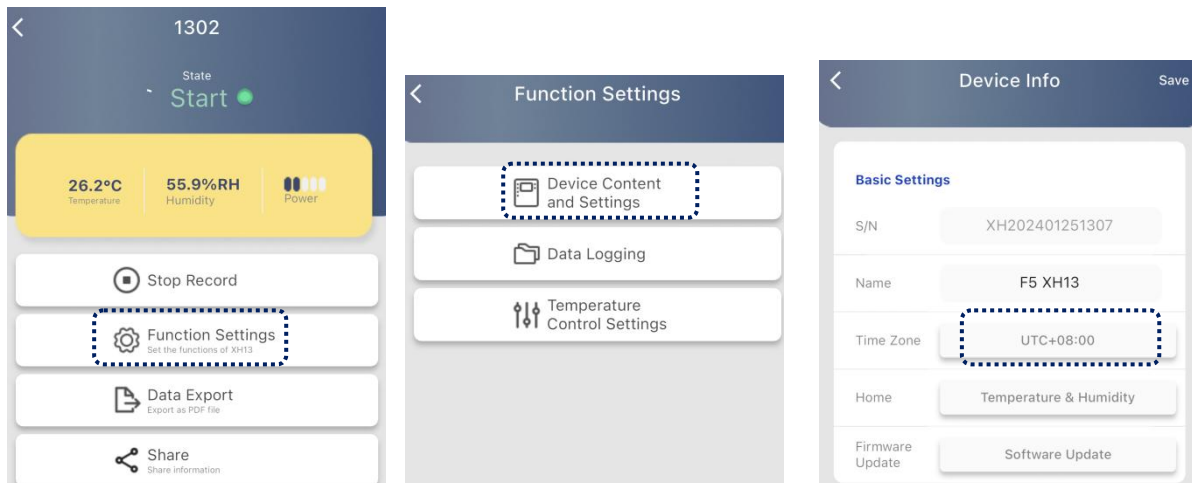

*** ⚠ Note:

Notice! Reset Time Zone under <Parameter> and save to exit again even if your local time is UTC+8:00, the same as the default. <Save> again to activate.

❖ **Set Log Interval**

The step is required to activate the system, resetting log interval to unlock the default setting.

- Select one connected XH name, which connected shown green light. Tap [•••] State in the upper right corner to enter this single device configuration. Set the interval (H/M/S) not all zero.
- Tap [Function Settings] > [Data Logging] to select the log interval HMS hour/minute/second interval at least one not zero, and then tap [Save] to exit.

*** ⚠️ Note:

Notice! Reset log Interval under <Parameter> and set the number at least one not zero.

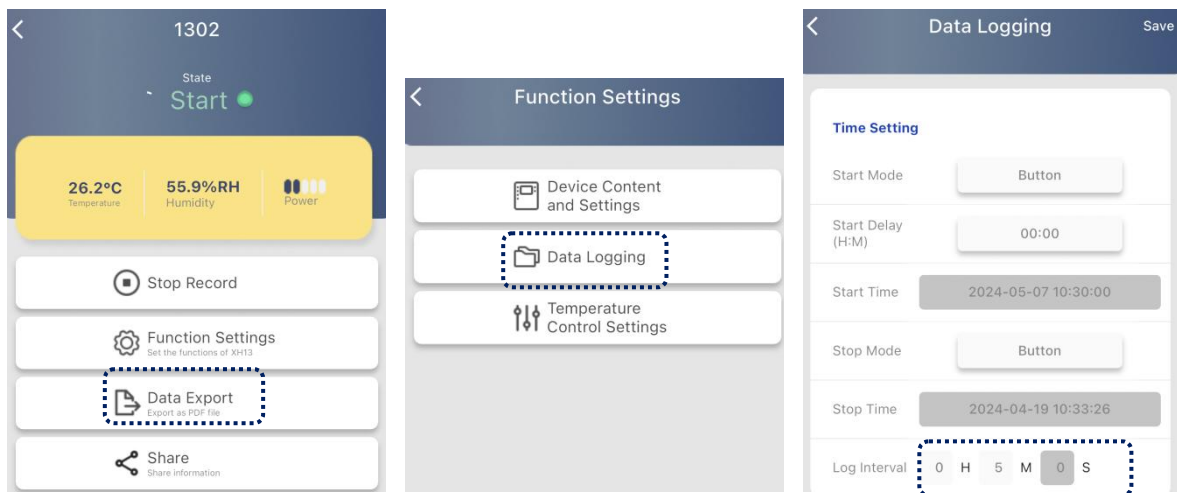

❖ **Change the language interface**

To change language of App, XH Logger App for XH13 application only supports certain language interface currently, if you need to change the language to Chinese or English, please change the language of your mobile device. For iOS users, go to Settings> General > Language & Region.

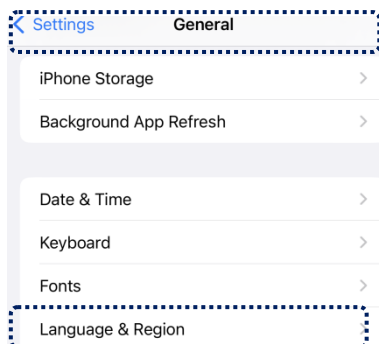

❖ **Start Recording**

Reset Time Zone under <Parameter> and save to exit. Reset log Interval under <Parameter> and set the number at least one not zero.

➤ **Start Recording immediately:**

Select one connected XH name. Tap [•••] State in the upper right corner to enter this single device configuration. Tap [Start Record].

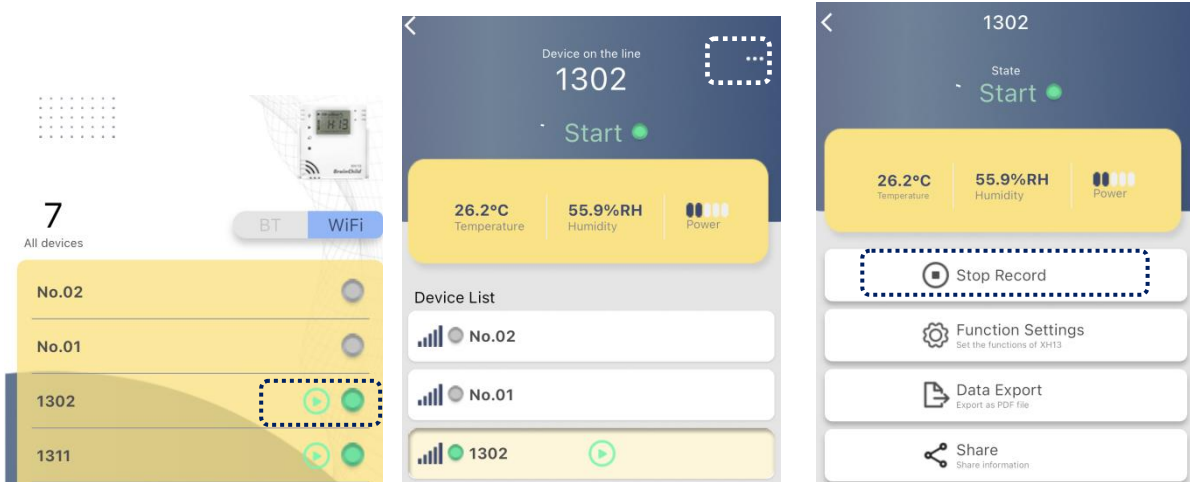

➤ **Scheduled Session Start:**

Tap [•••] State in the upper right corner to enter this single device configuration. Tap [Function Settings], and select [Data Logging]/ [Start Mode > At Time]. Select the time setting details [Start Time/Stop Time], and then tap [Save] to exit.

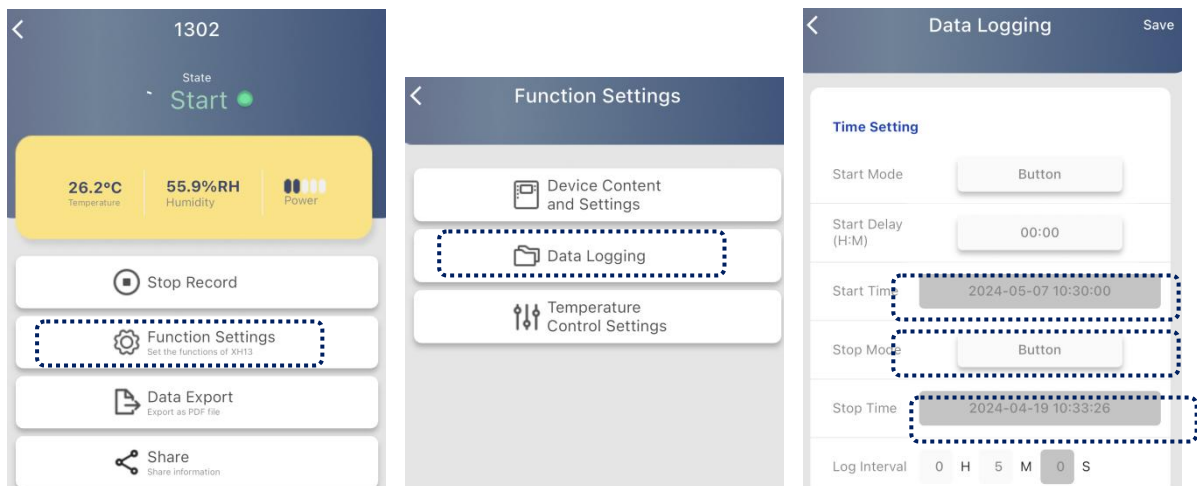

2.2.2 Firmware Update via XH13 App

❖ Firmware Update

Update XH13 via XH13 App (Wi-Fi connected)

Update Firmware to the latest version

- Select one connected online XH, which connected shown green light. Tap [•••] State in the upper right corner to enter this single device configuration.

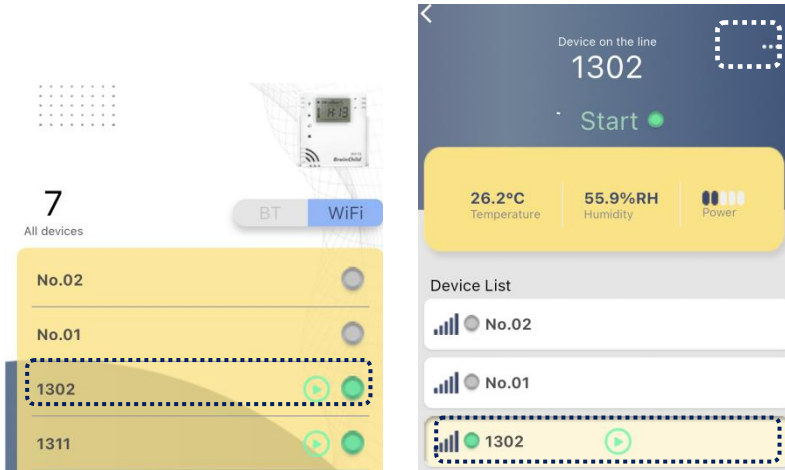

- Tap [Function Settings] > [Device Content] > [Firmware Update]>>Software Update] to update the firmware to the latest version, and then tap [Save] to exit.

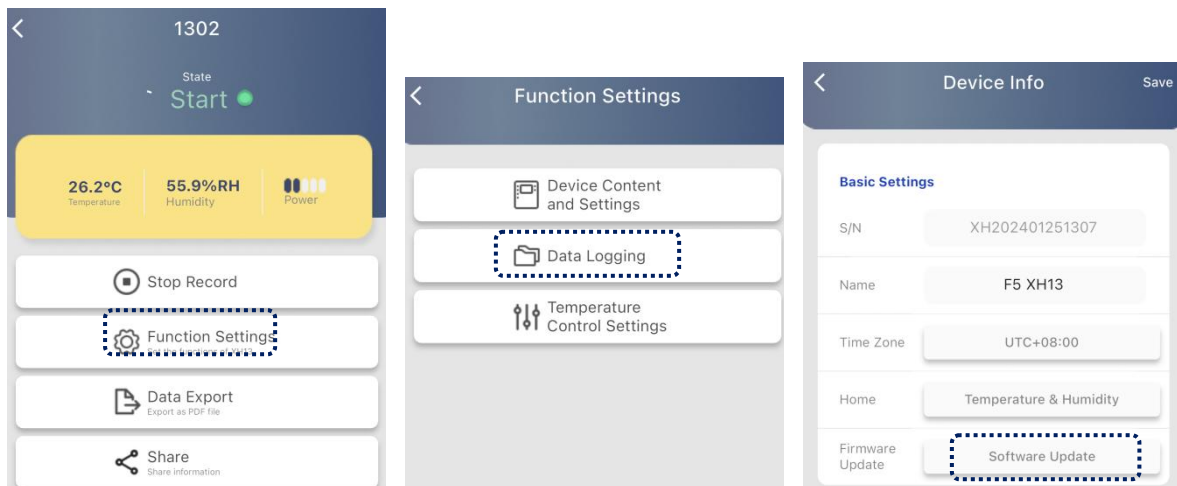

*** ⚠ Note:

Notice! Do not disconnect the device or press any button until the firmware update is complete.

2.3 XH13 Cloud Web Pairing

2.3.1 Cloud Web Registration & Activation

❖ Cloud Web Registration and Login

Add one brand new XH13 device via XH Logger App and complete pairing XH13 with Wi-Fi, simply scanning the QR code on the back of the XH. Register and login to the XH13 Cloud from the original manufacturer cloud-platform, entering <Device Management>.

*** ⚠️ Note:

Notice! Please note that XH13 could only newly being added from the App.

- Please finish cloud registration, <https://cloud.brainchildtw.com>.
- Please finish registration in the App and pair the device via the App.
- Login to the webpage using owner accounts, <https://cloud.brainchildtw.com>. Please note that XH13 could only newly being added from the App.
- After cloud registration, login to the web. Click on the left upper corner [Device Management], and then enter device operation.

🏠 Register now

name

Email URL Send email

Verification code verify

phone number

password

Register an account
log in

Log in now

Email URL

password

log in

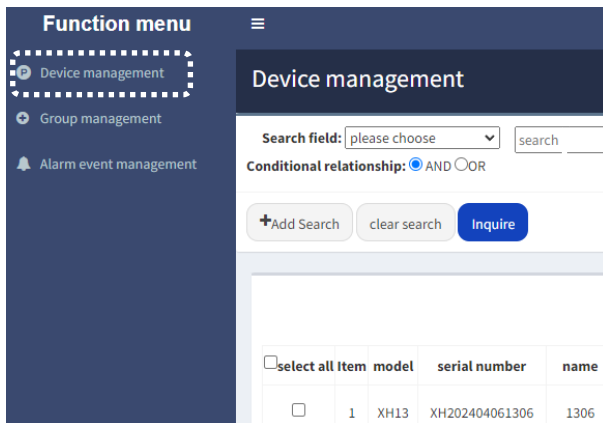

❖ **Add a New XH13 to Cloud Web account**

➤ A new XH13 hardware device can only be added from the App version by scanning the QR code on back-cover of the product.

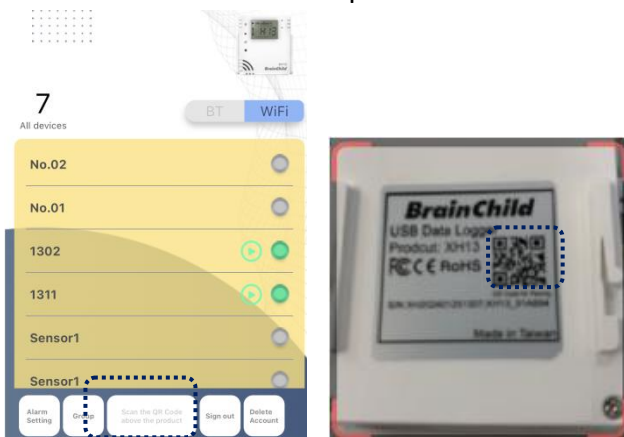

➤ After pairing, login to web account, the new XHLogger will appear on the device list.

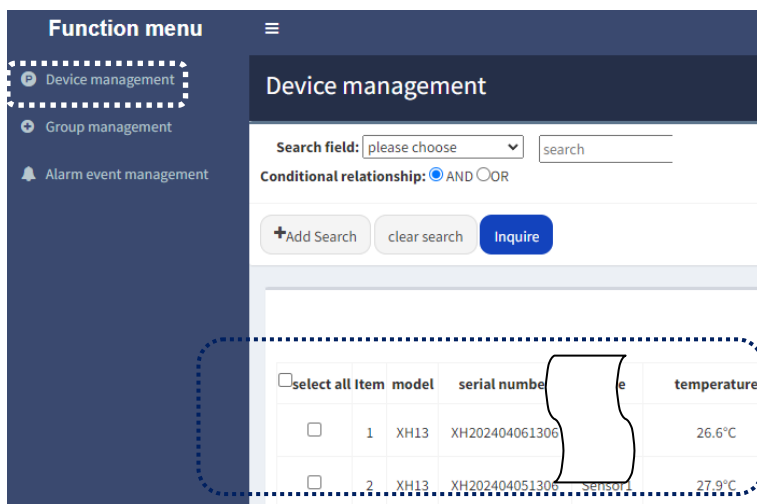

❖ **Alert Email Notification**

Users need to register new accounts on App/ Webpage using email as login IDs. The error messages will send to this email for notification. Select a frequently used email account as receiving alerts email when temperature/humidity occurs abnormal.

Log in to the web. Click on the left upper corner [Alert event management], and then enter event management.

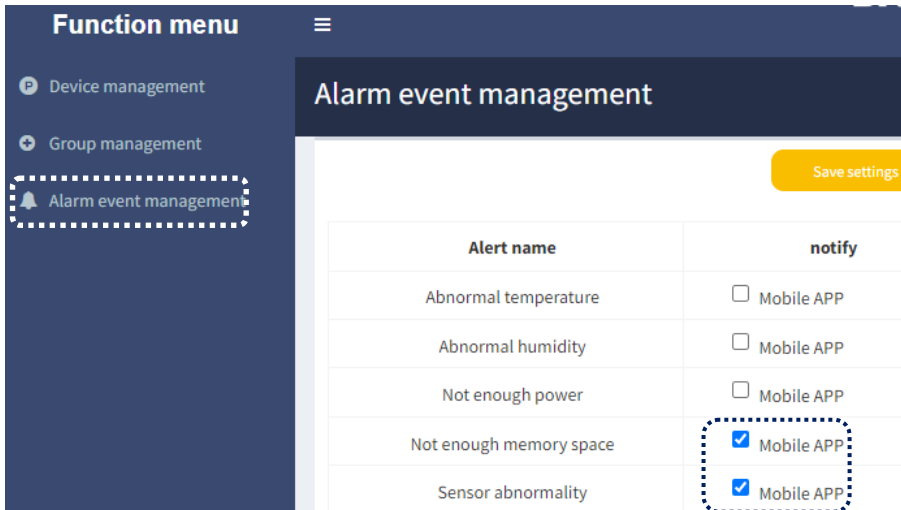

❖ **Change Password**

Reset the password by clicking the right-upper corner, <change password>, reset the password and send out.

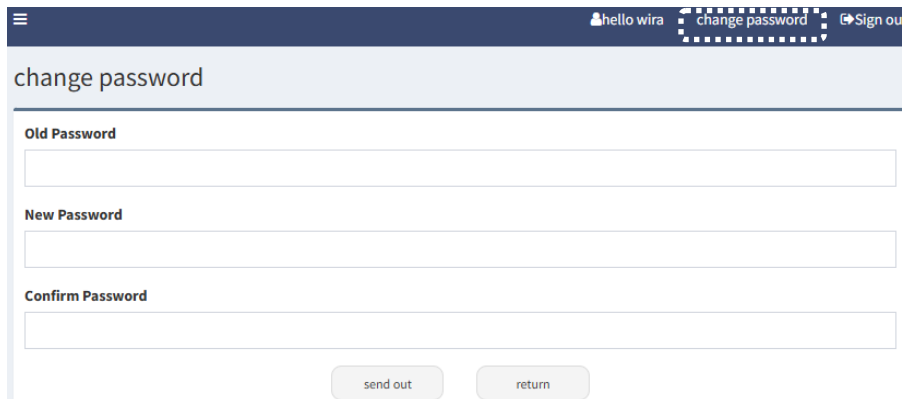

❖ **Share and Edit List**

Share/ Edit List from the XH13 cloud web

Log in to the website using an Owner account, <https://cloud.brainchildtw.com>. Select an online XHLogger from the device list. Click the green button [Share]. Input a member email address, and select permission type. Click the blue button [Share]. After configuration, the share account can also receive alert emails when system sends alerts notification during abnormality of temperature/humidity.

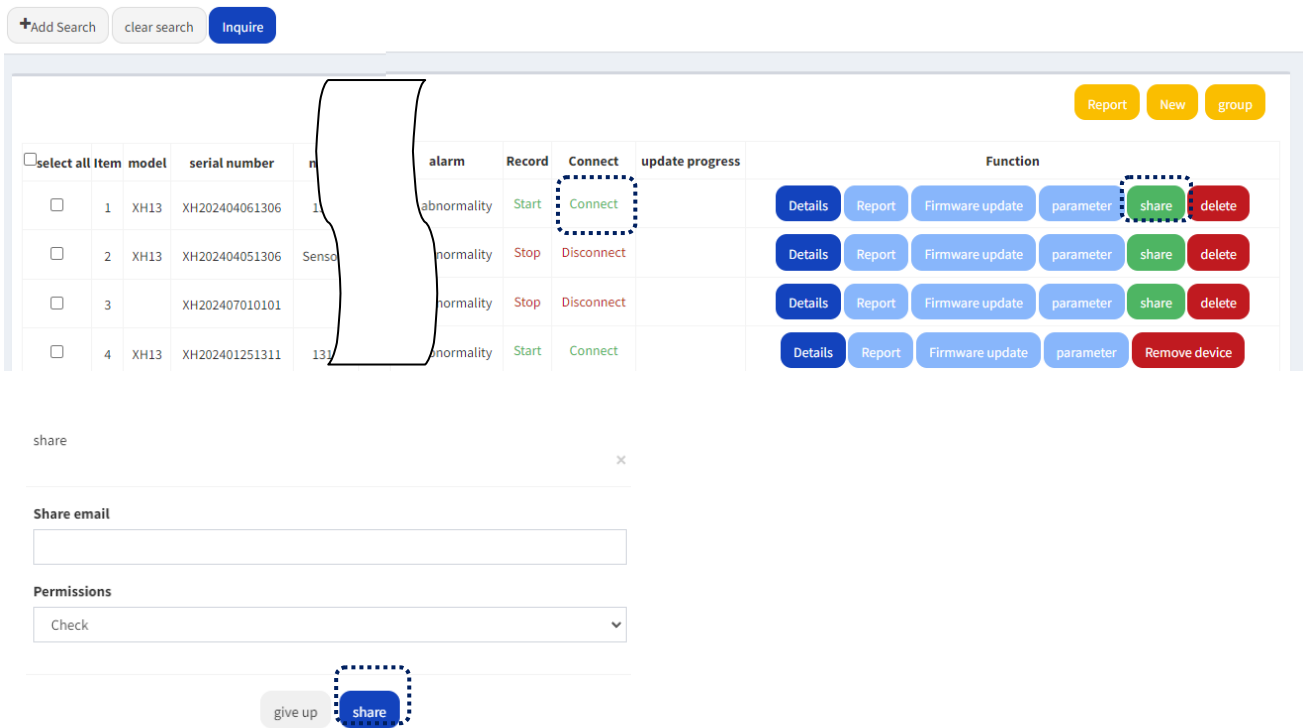

From the share list, edit the members, permission, and etc.

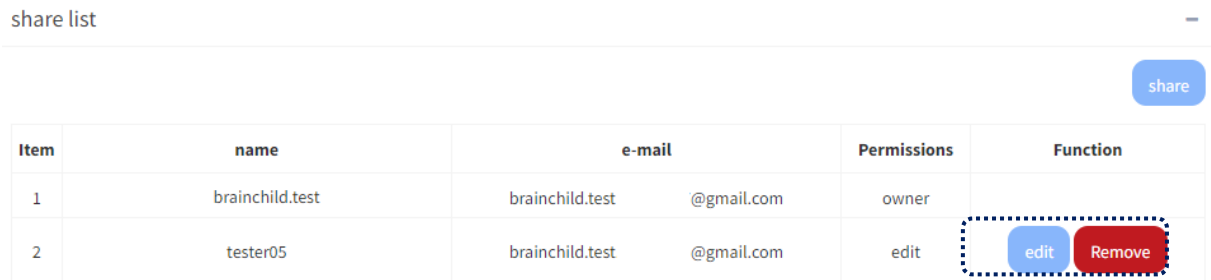

Share/ Edit List from the XH13 cloud web

Log in to the App, and select one XH already connected online. Tap [•••] “State” in the upper right corner to enter this single device configuration. Tap [Share] > [New] to add a new member to the [Share] list.

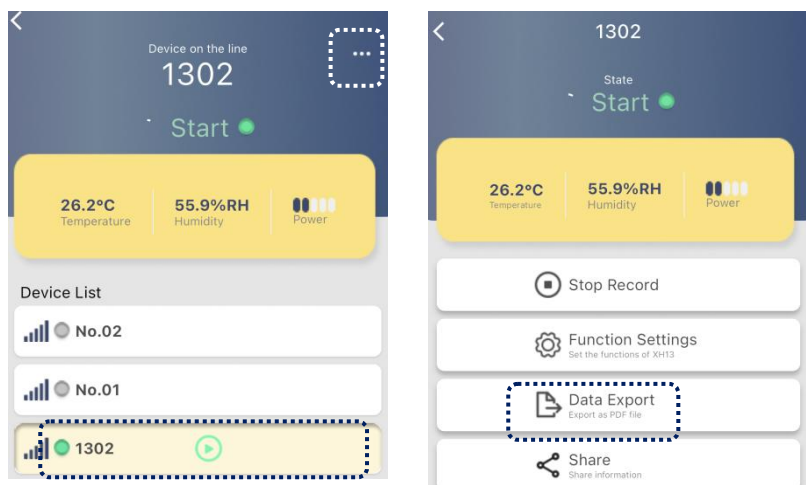

❖ Exporting Reports

Upgrade via XH13 Cloud Web:

- [Function Menu] -> [Device Management]
- Enter [Device Management] > [Report]. Inquire and export report by selecting the specific date range

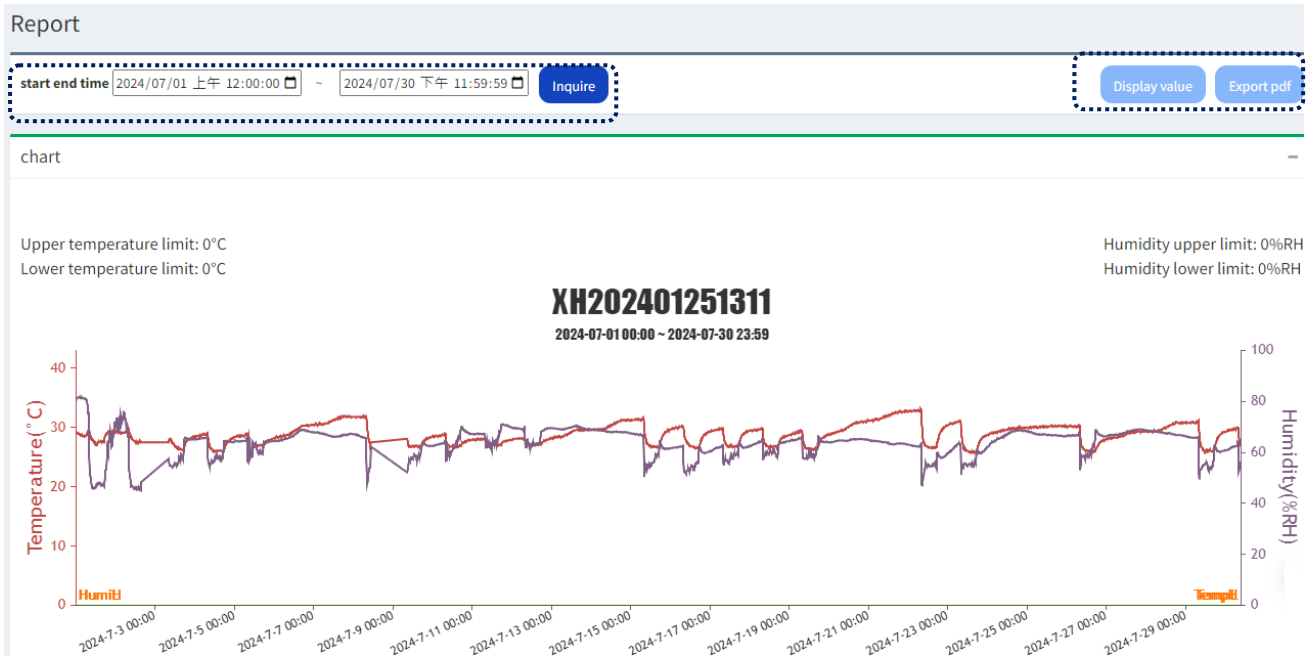

❖ Error Report

Upgrade via XH13 Cloud Web:

Search data and Inquire on the event overview.

front page

The dashboard features three semi-circular gauges. The first gauge, labeled 'In operation', has a green segment and a value of 3. The second gauge, labeled 'battery warning', has a red battery icon and a value of 0. The third gauge, labeled 'Other warnings', has a red warning triangle icon and a value of 0. Below the gauges is an 'Event overview' section with a pagination bar showing page 1 of 846. It includes search filters for 'start end time' (2024/07/01 上午 10:05 ~ 2024/07/30 上午 10:05) and 'alert type' (all). There are 'clear search' and 'Inquire' buttons. A list of events is shown, with the first entry being 'XH202404021302 Abnormal humidity' with a timestamp of 2024-07-30 08:42:04.

2.3.2 Cloud Web Registration & Activation

❖ **Firmware Update**

Upgrade via XH13 Cloud Web (Wi-Fi connected):

Firmware Update procedure as follows:

- Connect and link with XH13 Cloud Web wirelessly
- Download the latest firmware from the original manufacturer official website
- Register & Login to XH13 Cloud

[Register now](#)

name

Email URL

Send email

Verification code

verify

phone number

password

Register an account

log in

- Complete XH13 pairing with App wirelessly

Home -> [Scan the QR Code...] -> Scan the XH back cover -> [Join]/[Connect] -> S/N shown -> SSID/WiFi/WiFi pwd -> [Save] -> [Ok]. Pairing has been completed.

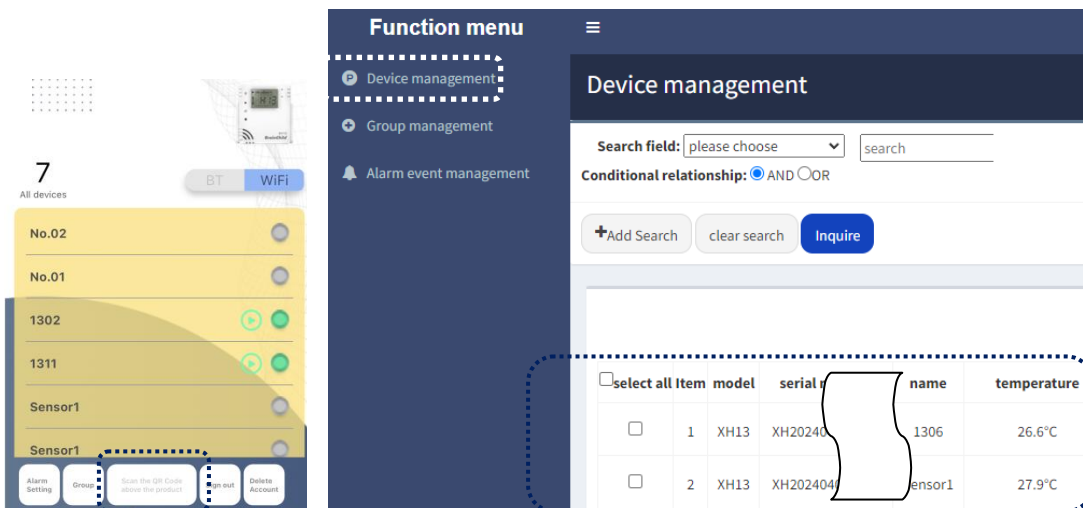

- Update the XH13 firmware to the latest via XH13 Cloud
 XH13 Cloud Home, tap [Function Menu] -> [Device Management] -> select one online wireless connected XH13 -> [Firmware update]. Follow steps to complete the firmware update.

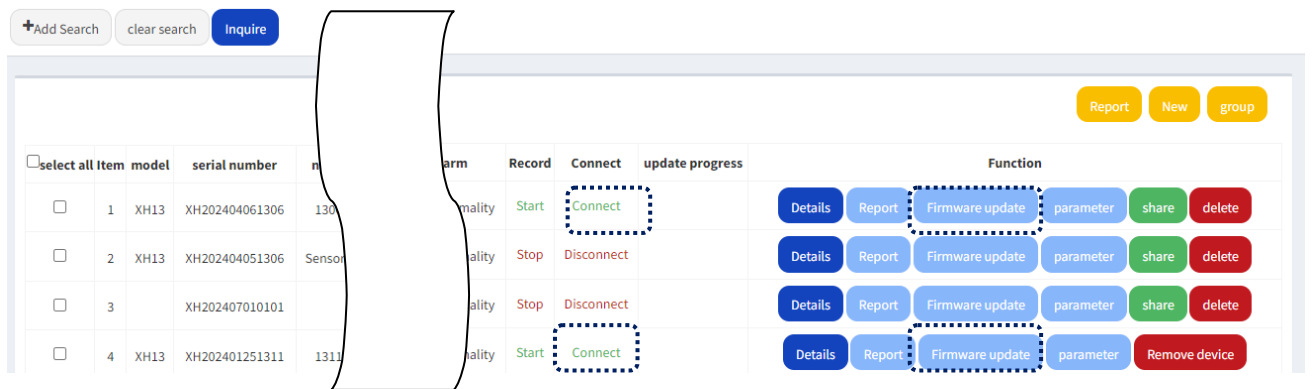
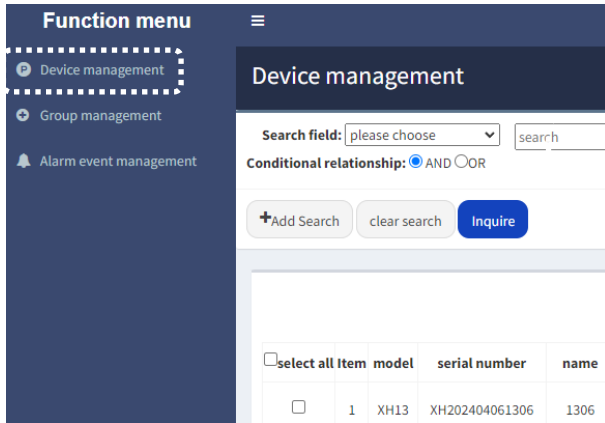

***  Note:

Notice! Follow steps to complete the firmware update and do not disconnect during update. Also keep XH13 online continuously during update. By saving the latest firmware to PC/mobile, you can easily manage device and upgrade firmware.

3 Operation Mode and Keypads

3.1 XH13 Operation

3.1.1 XH13 Operation of Keypads

Action	XH13 three keypads
Start ▶ – Short press	Reconnection
Start ▶ – Long press	Start recording
SCROLL/MENU ↻ – Short/ Long press	Toggle screen/ menu views
Stop ■ – Press & hold for 5 times continuously	Reset and clear all old pairing
Stop ■ – Long press 3 sec	Stop recording after logging
Stop ■ – Long press 3 sec after stopping	Sleeping mode before logging
Any key ▶ / ↻ / ■ – Short press	Wakeup from sleep mode
Restart button: Press a white button on the board from the back panel	Restart the device; please refer to the chapter, XH13 Restart button

3.1.2 XH13 Operation Mode

Start Recording	XH13 Description
Immediate (App)	Immediate recording after configuration when setting activation from the App
Button (XH13)	Long Press START ▶ key for more than 3 sec when setting the XH through App
	The button mode also working with <Start Delay>, long press START ▶ key for more than 3 sec. When reaching the start delay time, it will automatically start recording
Specific Time (App)	Start recording when reaching the specific time, when setting from the App
Stop Recording	XH13 Description
None	Stop by App configuration
Button	Long press STOP ■ key for more than 3 sec at logging mode, or stop by App
Specific Time	When reaching the stop time, it will automatically stop recording

3.2 Operation Modes

There are types of operation modes available for XHLogger series. They are listed as below.

❖ Logging Mode

At logging mode, the green LED will be flashing every 4 seconds.

Start Recording:

1. Immediate: After setting the XH logger through cloud/App, it will start logging mode.
2. Button: Once the user press the ► START key for more than three seconds at monitoring mode, the logging mode starts on and the LCD ► will be flashing. The flashing logging icon indicates the device is waiting to be started to log, while ► remaining on display means recording is in process and entering the logging mode. The measuring value is saved periodically in the flash memory at logging mode according to the preset logging
3. Specified time: Set the specified time through the cloud/App wirelessly. The LCD logging icon will be flashing. Until the specified time is reached, it will automatically start the logging mode.

Stop Recording:

1. None: After logging mode has started, logging mode can only be stopped from the cloud. After logging mode has started, logging mode can be stopped from the cloud settings (web-page/ App) for XH13.
2. Button: Once the user press ■ STOP key for more than 3 seconds at logging mode. It will stop recording, enter the monitoring mode and ► will disappear.
3. Specified time: After logging mode starts, when the specified stop time is reached, it will automatically stop recording and ► will disappear. The logging mode can be stopped from the cloud settings (web-page/ App).
4. Recording Delay Timer DLY: Recording Delay means that the time to start recording will be delayed by the DLY setting, and the flashing ► indicates that the unit is waiting to start recording.

❖ Monitoring Mode

Once the user presses the ■ STOP key for more than 3 seconds while the device is at logging mode, the monitoring mode starts, stops recording and ► will disappear. Red LED will be flashing every 4 seconds and the LCD screen will still show the current measuring value of temperature and humidity, but it won't be saved in flash memory, with a sampling rate at 10 seconds.

If a device's LCD is not at the home screen, i.e., (at alarm screen ALM), the screen will stay up to 8 seconds, and then changes itself to the home screen to show the current measurements.

The LED screen can be set displayed info from the cloud settings (web-page/ App) for XH13.

❖ Shutdown Mode

The shutdown mode can only be entered via a device is at monitoring mode. Once the user press ■ STOP key for more than three seconds while the device is in Monitoring mode, the device enters the shutdown mode. This will turn off LCD, LED, and all circuits except real-time clock (RTC) function at the device. If the device is operating under this mode, the battery life can exceed years. Since this is the most power-saving mode for the device, only the RTC circuit is running and all other features will be shut down. After replacing the battery and restarting the power supply, the device must be connected to the USB power. The user can press any key to bring the device back to monitoring mode. If the unit does not respond, perform a system restart. After the cloud (web-page/ App) updates the date and time, the user can use the logging function for XH13.

❖ System Restart

If somehow, a device can't respond to a user, the user can press ► + ↻ + ■ <START>, <SCROLL> and <STOP> three keys for more than 1 second simultaneously and then release, the system will restart. If you start it too fast and the restart fails, the screen will stop updating and you need to restart the system again.

When XH13 failed to respond, for the second way to restart the device, you need to reboot the system by disassembling the hardware. On the lower right side of the board, there is a white button for rebooting the system immediately. You need to remove the back cover and press the white button on the main board. Please refer to the section, Restart button.

3.3 Reboot Button

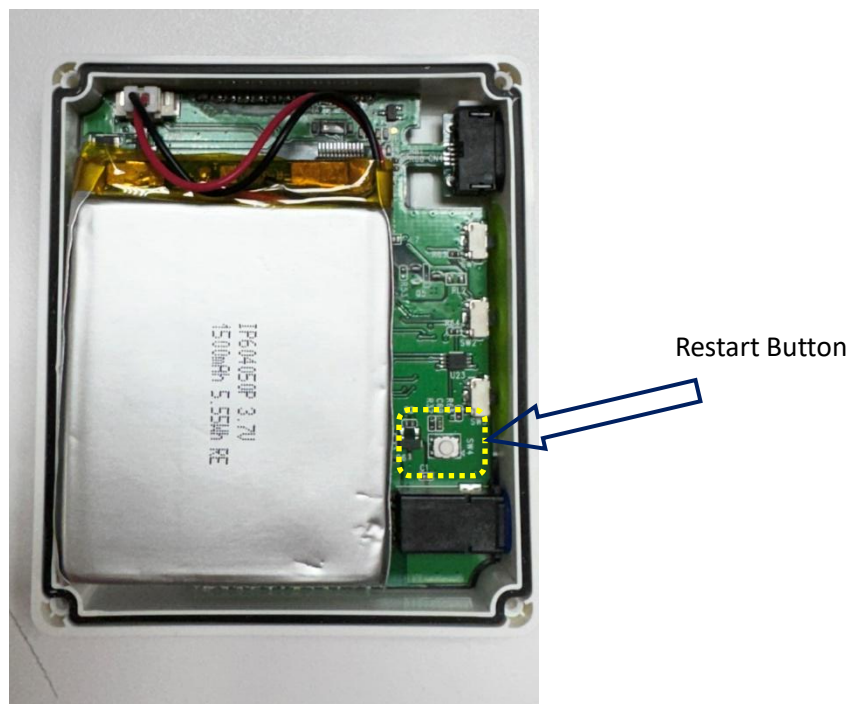
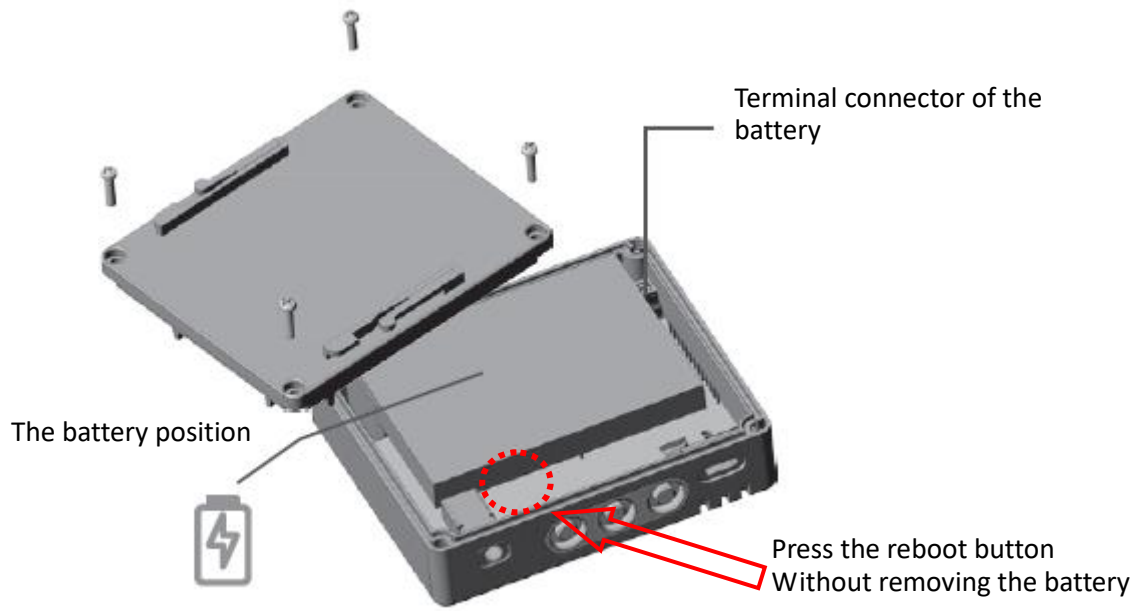

4 LED Display

Flashing red LED indicates one of the following cases:



- (1) The device is working at the monitoring mode.
- (2) Either a High/ Low Limit (HL, LL) exceeded, it will trigger an alarm.
- (3) When there is no battery bar icon at the LCD display, it indicates that the battery level is extremely low. Please follow the chapter, Battery, to replace new batteries carefully.
- (4) The usage of entire device memory has reached 95% of its total capability.
- (5) There is an error on the device.

4.1 LED Signal Lights

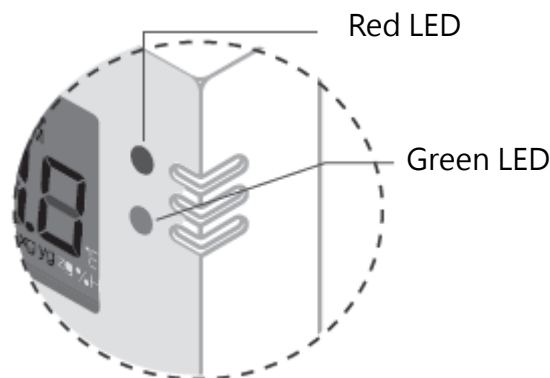
- ❖ Power Up: Flashing Red/ Green LED, indicating devices startup successfully
- ❖ Logging/ Monitoring Mode: Flashing Green LED, indicating working in recording monitoring mode
- ❖ Error Mode: Flashing Red LED, indicating errors occurred, alarms triggered
- ❖ Interruption mode: Red LED blinking 3 times & off continuously, when the connection is interrupted



5 Error Code

LCD display will flash the current measured value and error code alternately at an every two-second interval. If there is an error  symbol will appear on LCD screen. If there is no error, the  will not appear on the LCD display

5.1 XH13 Error Code

XH13 Data Logger

Error Code	Reason
Er01	Wi-Fi module abnormal disconnection, failed to start, please restart or reset
Er02	Cloud registration failure, please registration and pairing again
Er03	Login failed, please check whether ID/Password is correct, Wi-Fi signal as stable
Er04	AWS/MQTT connection failure, please check your network connection working
Er05	Wireless AP failed to connect, please check if the router is working properly.
Er06	Sensor failure, please contact local dealers or the original manufacturer Firstly check whether the external sensor connected correctly firmly
Er07	Device time stamp not available, device timer abnormal. Please connect to the XL Logger cloud/ App to synchronise the time. Reset the time zones. (1)(2)
Er08	The total files exceed the limitation and the memory is full. Please backup all data, or it will automatically overwrite the past data
Er09	Start recording without setting parameters, logging interval error, setting/ configuration error. Please reset log interval. (1)(3)

** An error icon  will appear when any error occurred/ red led flashing

+Add Search clear search Inquire

Report New group

<input type="checkbox"/> select all	Item	model	serial number	name	alarm	Record	Connect	update progress	Function
<input type="checkbox"/>	1	XH13	XH202404061306	1306	No abnormality	Start	Connect		Details Report Firmware update parameter share delete
<input type="checkbox"/>	2	XH13	XH202404051306	Sensor1	No abnormality	Stop	Disconnect		Details Report Firmware update parameter share delete
<input type="checkbox"/>	3		XH202407010101		No abnormality	Stop	Disconnect		Details Report Firmware update parameter share delete
<input type="checkbox"/>	4	XH13	XH202401251311	1311	No abnormality	Start	Connect		Details Report Firmware update parameter Remove device

(1)

< Device Info Save

Basic Settings

S/N XH202401251307

Name F5 XH13

Time Zone UTC+08:00

Home Temperature & Humidity

Firmware Update Software Update

(2)

< Data Logging Save

Time Setting

Start Mode Button

Start Delay (H:M) 00:00

Start Time 2024-05-07 10:30:00

Stop Mode Button

Stop Time 2024-04-19 10:33:26

Log Interval 0 H 5 M 0 S





(3)

6 Battery

6.1 XH13 Battery

6.1.1 XH13 Power Supply

The wireless XHLogger has two types of power supply, USB powered with charging and battery powered. The XH13 uses a rechargeable battery; when charging, connecting USB port to power supply DC5V/1A. ($\geq 1A$). When battery powered being used, being reused depending on usage, the battery life cycle and charging cycle varies. When USB-power used, the battery will not consume power during operation.

When the battery power shown   low, please recharge the battery sooner. If the battery is completely drained   (failed to wake it up by pressing any button on the device), it is recommended to recharge or replace to new one and backup data, when the device completely no power, or less than 20%. If completely no power after charging, the internal power applied to RTC (Real Time Clock) is completely drained, unable to wake up by pressing any key. Please replace one new battery.

6.1.2 XH13 Battery Replacement

- * If the power is low or completely no power after charging, please check the installation or the terminal port, if it is properly located, whether the battery broken or life-expiration. If the battery is not inserted well or replacement needed then insert the battery provided, following the instructions below. Or, contact your local dealer for original manufacturer replacement.
 - ① Loosen and remove 4 screws
 - ② Open and remove the back panel. Disassemble the terminal cable from the port and take out the old battery
 - ③ Replace a brand new rechargeable Li-ion battery. Connect the terminal cable to the port and place the battery firmly to the position.
 - ④ Install the back cover and tighten the screws

Be aware of the direction when covering the back panel, and be aware of the waterproof rubber ring, if it is properly located. Tighten the screws on the back panel but not excessively, the locking torque: 1Kg-cm (not more than 1.5Kg-cm)

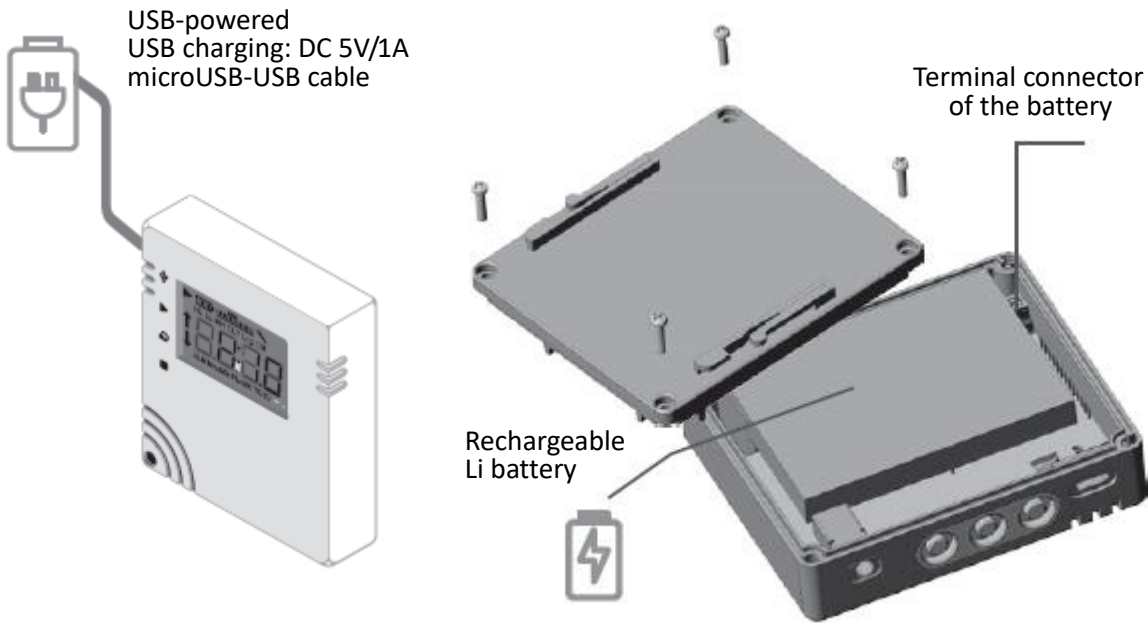





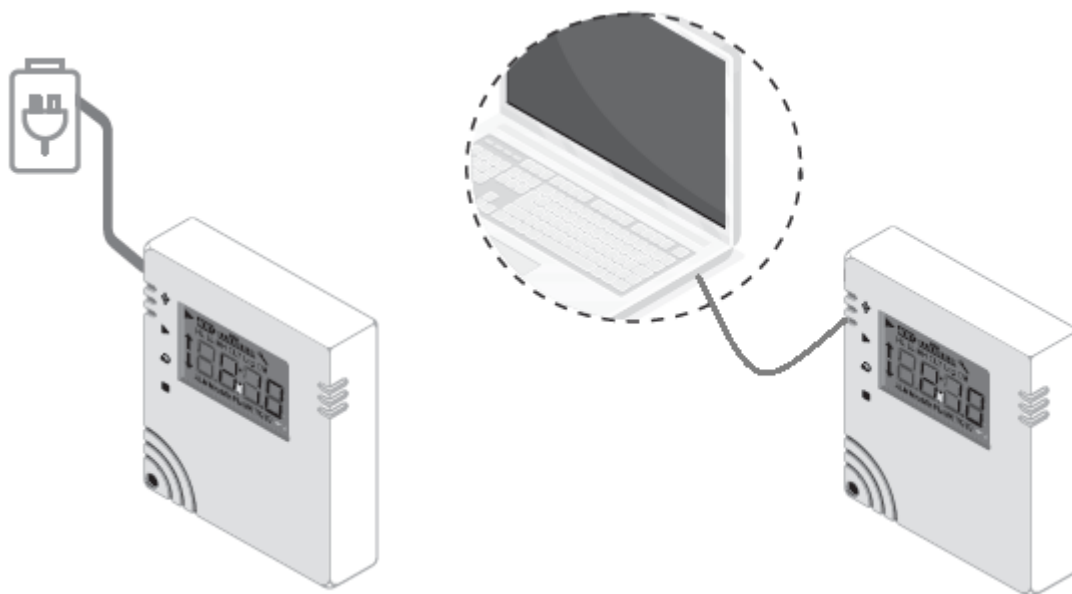

6.1.3 XH13 Battery Charge

- *  The XH13 use a rechargeable battery; when receiving the brand new product, before usage for the first time, please charge the new device to full level via USB port. Use one micro USB-USB cable, connecting USB port to power supply DC5V/1A. ($\geq 1A$) When the device completely no power, less than 20%, the totally charging time to fully charged takes around 4 hours to finish with connecting to DC5V/1A charging adapter. For normal usage, recharge the device every 2 to 3 months.



6.2 XHLogger Battery Level and Percentage

Battery Level 0~4	Level & Percentage
	4 scales: Power 100%
	3 scales: Power 80%
	2 scales: Power 60%
	1 scale: Power 40%
	0 scale no blinking: Power < 20%
	0 scale + blinking: Power < 20%

7 Product FAQ

** ⚠ If you have any other tech problems, please contact our FAE and provide the serial number on the sticker from the back of the device.

Q1: When the XHLogger turns on, starting recording mode, “ER09” is displayed on the screen.

A1: When Error code <ER09> shown on the startup screen, it refers to the parameter setting not been completed yet. Please reset log interval. Reset log Interval under <Parameter> and set the number at least one not zero.

➤ Tap [Function Settings] > [Data Logging] to select the log interval HMS hour/minute/second interval at least one not zero, and then tap [Save] to exit.

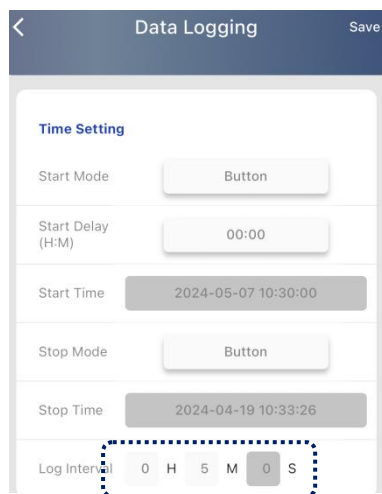

Q2: Can the XH external sensor cable be replaced?

A2: Yes, the external sensor cable can be replaced, sharing usage with the same module.

Q3: Can the XHLogger, XH, external sensor cable be immersed in liquid?

A3: No, the XHLogger external sensor cable is designed for measuring the ambient temperature/humidity, cannot measure the liquid temperature. If soaking in liquid causes to malfunction, the wire must be replaced.

A4: How to operate the reboot button?

A4: Short press & hold press three keys ▶ + ↺ + ■ simultaneously.

Or remove the 4 screws and the back cover. Press the white reboot button on the board. Please refer to the section, XH13 reboot button.

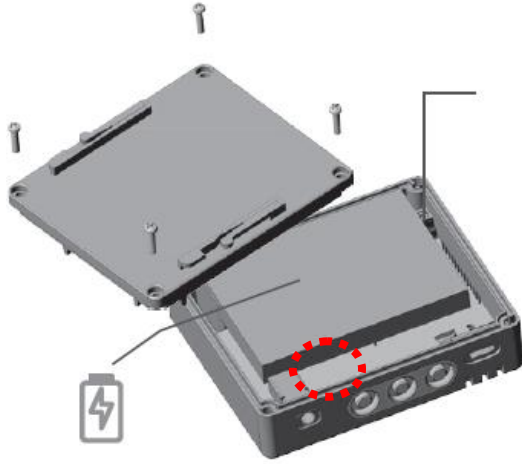

Q5: How to receive alerts via Email?

A5: Users need to register new accounts on App/ Webpage using email as login IDs. The error messages will send to this email for notification. Select a frequently used email account as receiving alerts email when temperature/humidity occurs abnormal.

Q6: How to add a new XH13 device to cloud web account?

A6: A new XH13 hardware device can only be added from the App version by scanning the QR code on back-cover of the product. After pairing, login to web account, the new XHLogger will appear on the device list.



Q7: How can I share XH13 devices with other members ?

A3: Log in to the website using an Owner account, <https://cloud.brainchildtw.com>. Select an online XHLogger from the device list. Click the green button [Share]. Input a member email address, and select permission type. Click the blue button [Share]. After configuration, the share account can also receive alert emails when system sends alerts notification during abnormality of temperature/humidity.

											Report	New	group			
<input type="checkbox"/> select all	Item	model	serial number	name	temperature	humidity	alarm	Record	Connect	update progress	Function					
<input type="checkbox"/>	1	XH13	XH202404061306	1306	26.6°C	57.5%RH	No abnormality	Start	Connect		Details	Report	Firmware update	parameter	share	delete
<input type="checkbox"/>	2	XH13	XH202404051306	Sensor1	27.9°C	61%RH	No abnormality	Stop	Disconnect		Details	Report	Firmware update	parameter	share	delete
<input type="checkbox"/>	3	XH13	XH202404051306	Sensor1	27.9°C	61%RH	No abnormality	Stop	Disconnect		Details	Report	Firmware update	parameter	share	delete

Log in to the App, and select one XH already connected online. Tap [•••] “State” in the upper right corner to enter this single device configuration. Tap [Share] > [New] to add a new member to the [Share] list.

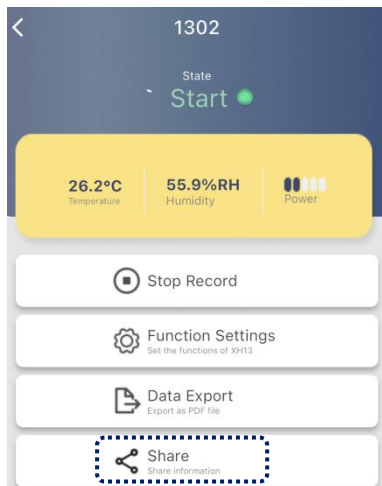

Q8: How to change the XH Logger App (XH13) language interface?

A8: To change App language, XH Logger App for XH13 application only supports certain language interface currently, if you need to change the language to Chinese or English, please change the language of your mobile device. For iOS users, go to Settings> General > Language & Region.

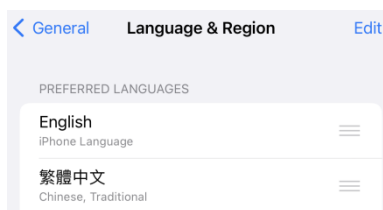

Q9: How to upgrade the firmware of the XH13?

A9: Connect and finish registration with the cloud. Pair your app with XH13 after registration. Please complete the App pairing/ XH13-web cloud registration and configuration firstly and download the latest firmware from the original manufacturer official website. Please refer to QSG, Pairing & Configuration. Firmware Update procedure as follows:

Upgrade via XH Logger App:

Register & Login to XH Logger App, Home -> [Scan the QR Code...] -> Scan the XH cover -> [Join]/[Connect] -> S/N shown -> SSID/WiFi/WiFi pwd -> [Save] -> [Ok]. Pairing has been completed. Home -> select one online XH13 -> [•••] (State) -> [Function Settings] -> [Device Content] -> [Software Update]. Follow steps to complete the firmware update and do not disconnect during update.

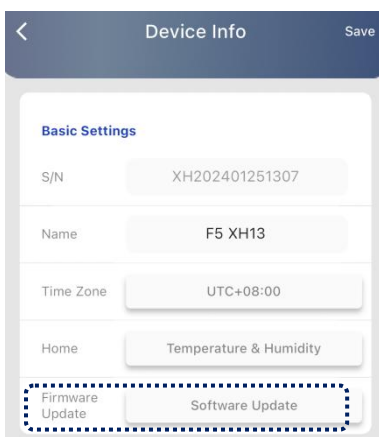

Upgrade via XH13 Cloud Web:

Register & Login to XH13 web, Home -> [Function Menu] -> [Device Management] -> select one online wireless connected XH13 -> [Firmware update]. Follow steps to complete the firmware update and do not disconnect during update. **By saving the latest firmware to this PC, you can easily manage device and upgrade firmware.

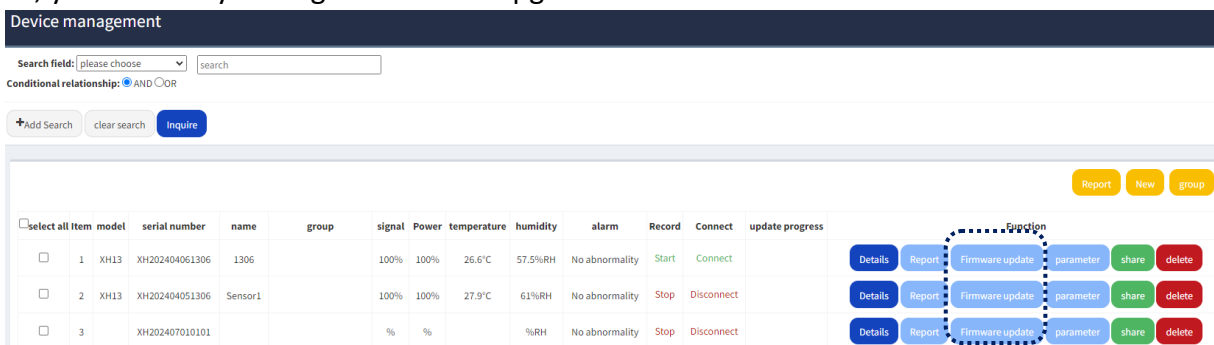

Q10: How to solve the problem about the abnormal power consumption of XH?

A10: For external sensor model, when poor contact occurred between the external sensor and the device, to improve the problem, try to unplug/re-plug the external sensor stick or rotate the sensor

8 Announcements

Batteries

Users are responsible for the proper disposal of the waste generated during their work. Improper waste disposal may severely endanger public health and/or the environment. Dispose the battery in accordance with local regulations.

- ❖ Most of our data loggers contain a lithium battery. Do not cut the battery open, incinerate, or recharge.
- ❖ Do not heat lithium batteries unless the battery is specifically rated for higher temperatures.
- ❖ Improper use of batteries may cause destruction of the batteries, injuries due to current surges, fire or leakage of chemicals.
- ❖ Do not short circuit the batteries or it may cause explosion due to current surges.
- ❖ Do not use any damaged batteries.
- ❖ Battery ER14250 must be used for replacement. Rechargeable type battery can't be used. Usage of rechargeable type battery may damage the device.

Disposal

Users are responsible for the proper disposal of the waste generated during their work. Improper waste disposal may severely endanger public health and/or the environment. Dispose the battery in accordance with local regulations.

Storage

Humidity measuring elements in data loggers can become contaminated by exposure to various compounds. These products should not be near volatile chemicals such as solvents and other organic compounds. Do not place the product near material or compound that emits a strong odor.

FCC Warning

Federal Communication Commission Statement

This device complies with FCC Rules Part 15. Operation is subject to the following two conditions:

- ❖ This device may not cause harmful interference.
- ❖ This device must accept any interference received, including interference that may cause undesired operation.

This equipment has been tested and found to comply with the limits for a class B digital device, pursuant to Part 15 of the Federal Communications Commission (FCC) rules. These limits are designed to provide reasonable protection against harmful interference in a residential installation. This equipment generates, uses, and can radiate radio frequency energy and, if not installed and used in accordance with the instructions, may cause harmful interference to radio communications.

However, there is no guarantee that interference will not occur in a particular installation. If this equipment causes harmful interference to radio or television reception, which can be determined by turning the equipment off and on, the user is encouraged to try to correct the interference by doing one or more of the following measures:

- ❖ Reorient or relocate the receiving antenna.
- ❖ Increase the separation between the equipment and receiver.
- ❖ Connect the equipment into an outlet on a circuit different from that to which the receiver is connected.
- ❖ Consult the dealer or an experienced radio technician for help.

FCC Caution

Any changes or modifications not expressly approved by the party responsible for compliance could void the user's authority to operate the equipment.

The antenna(s) used for this transmitter must not be co-located or operating in conjunction with any other antenna or transmitter.

Radiation Exposure Statement

This equipment must be installed and operated in accordance with provided instructions and the antenna(s) used for this transmitter must be installed to provide a separation distance of at least 20cm from all persons and must not be co-located or operating in conjunction with any other antenna or transmitter.

*The specifications and features in this manual are subject to possible change without prior notice.

Copyright © 2024 All Right Reserved.

For assistance contact tech Support:

service@brainchild.com.tw; 886-2-2786-1299